

FITMENT INSTRUCTIONS

Alu-Cab™

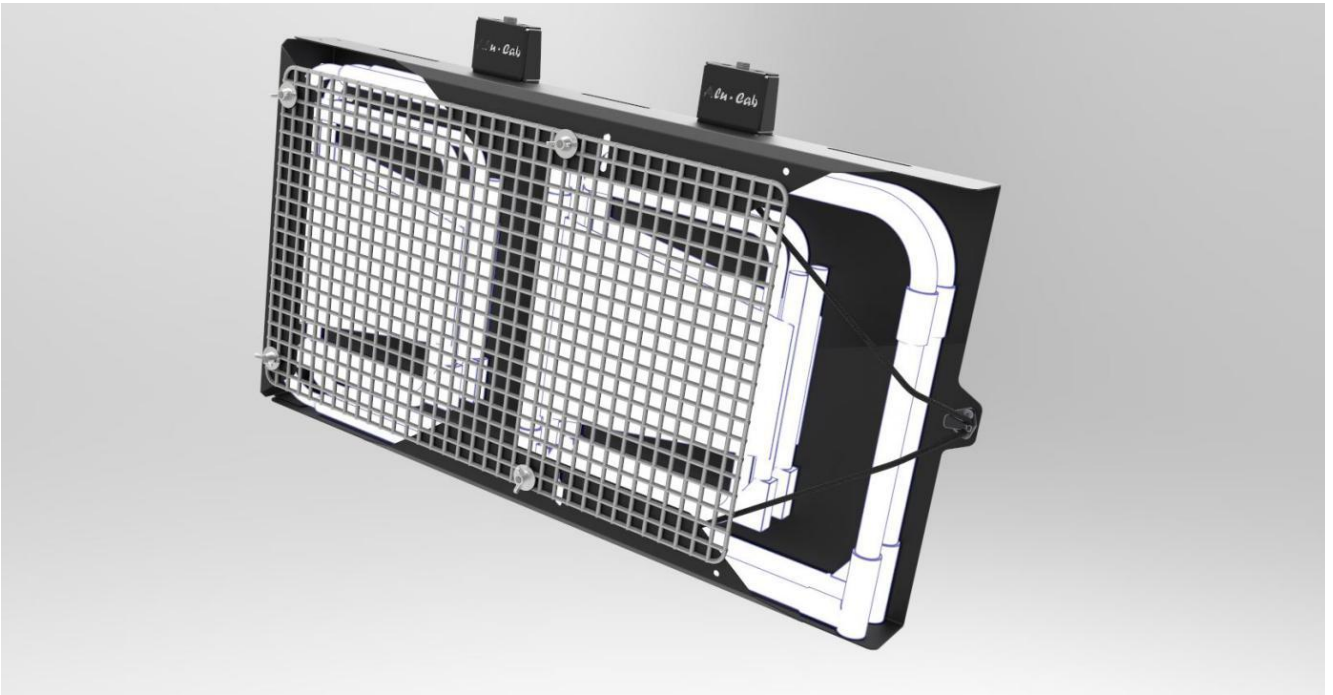

Side Chair Carrier

All rights reserved. No part of this document may be reproduced, translated, stored in a retrieval system, or transmitted, in any form or by any means, electronic, mechanical, photocopying, recording or otherwise, without prior written permission of the owner.

Review all instructions information carefully before installation.

Any damages, direct or incidental to the installer and/or property due to incorrect installation of any parts are the responsibility of the installer. Due to the various applications and fitment options available, the responsibility lies with the user to ensure all mounting points are secure and tight before every trip. If unsure, consult with your Distributor regarding the operations of our products.

Users are advised to be mindful of the load they are carrying and drive in accordance with road conditions.

DISCLAIMER

Alu-Cab

1. Side Chair Carrier Assembly - Fasteners & Components

The tables below show the equipment, fasteners and hardware required to complete the assembly and BOM of the Alu-Cab Side Chair Assembly.

1.1. Hardware supplied with the Side Chair Carrier Kit:

Side Chair Carrier		
PartNo	Description	Qty
RR-SC-000-003 Rev B	60mm Roof Rack Foot	2
461-SID-MAIN-BODY-01-03	Main Carrier Body	1
461-SHELF-MNT-BRKT-01-03	Shelf Mount Bracket	1
461-SHELF-KIT-BRKT-01-03	Shelf Bracket	1
403-BOT-MNT-BRKT-01-00	Cupboard Mounting Bracket	2
RR-SC-000-003 Rev B	60mm Roof Rack Foot	2
461-SHELF-MNT-BRKT-01-03	Shelf Mount Bracket	1
461-SHELF-KIT-BRKT-01-03	Shelf Bracket	1
461-SID-MAIN-BODY-01-00	Main Carrier Body	1
M8x16 Flat Washer	M8x16mm Flat Washer	10
M8x20 Cup Square Bolt	M8x20 Cup Square Bolt	4
Black Plastic Lace Hook 3	Black Plastic Hook for Bungy Cord	1
Rivet 4.8MMx10	Rivet Black 4.8MMx10 Blind	10
Braai grid	Braai Grid Large	1
M8 Nut Cap	M8 Nut Cap	10

M8 Nyloc Nut	M8 Nyloc Nut	10
461-BUNG-CORD-01-00	461-BUNG-CORD-01-00	1
M10X30MM FLAT WASHER	M10X30MM FLAT WASHER	4
M6x16 Button Head Cap Screw	M6x16 Button Head Cap Screw	9
M6 Nyloc Nut	M6 Nyloc Nut	9
M6 Flat Washer	M6 Flat Washer	18
M6 Nut Cap	M6 Plastic Nut Cap	9
M8x20 Button Head Cap Screw	M8x20 Button Head Cap Screw	6
Carpet	Carpet	1



Figure 1: Fitting Hardware

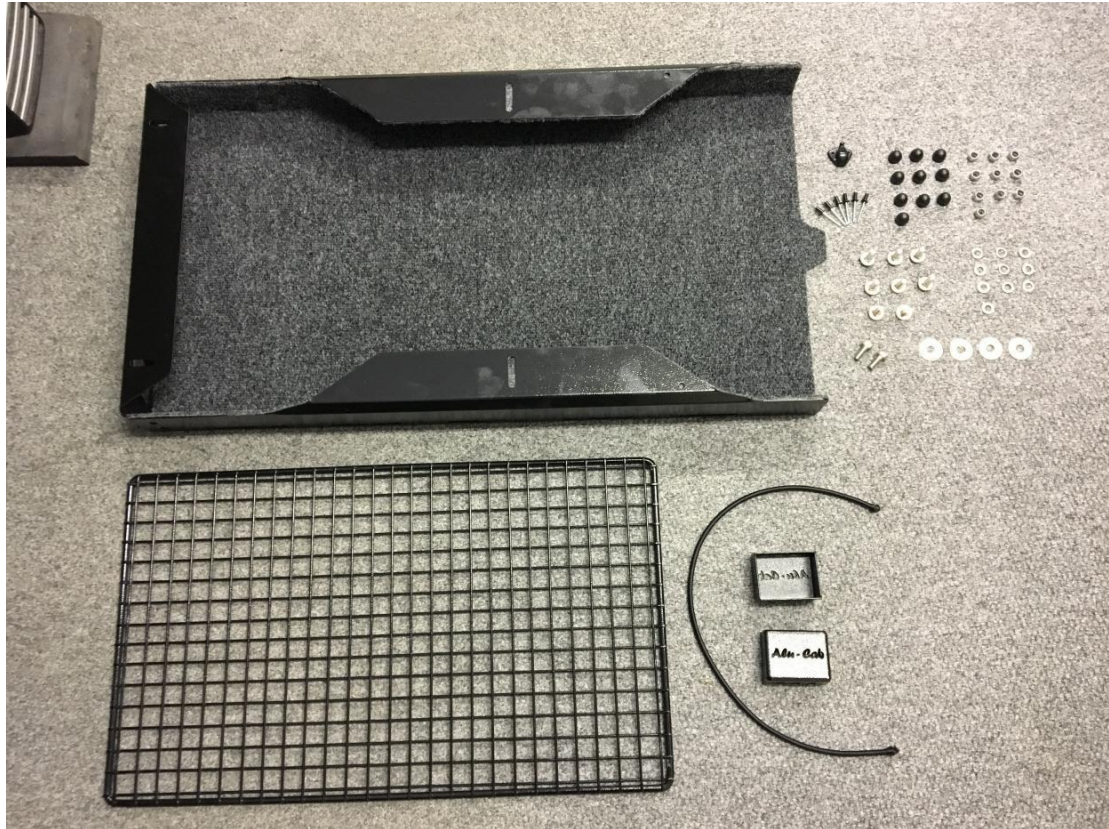

Figure 2: All Fasteners, Laser Cuts and Others

Side Chair Carrier Components:



Figure 3: Main Carrier Body

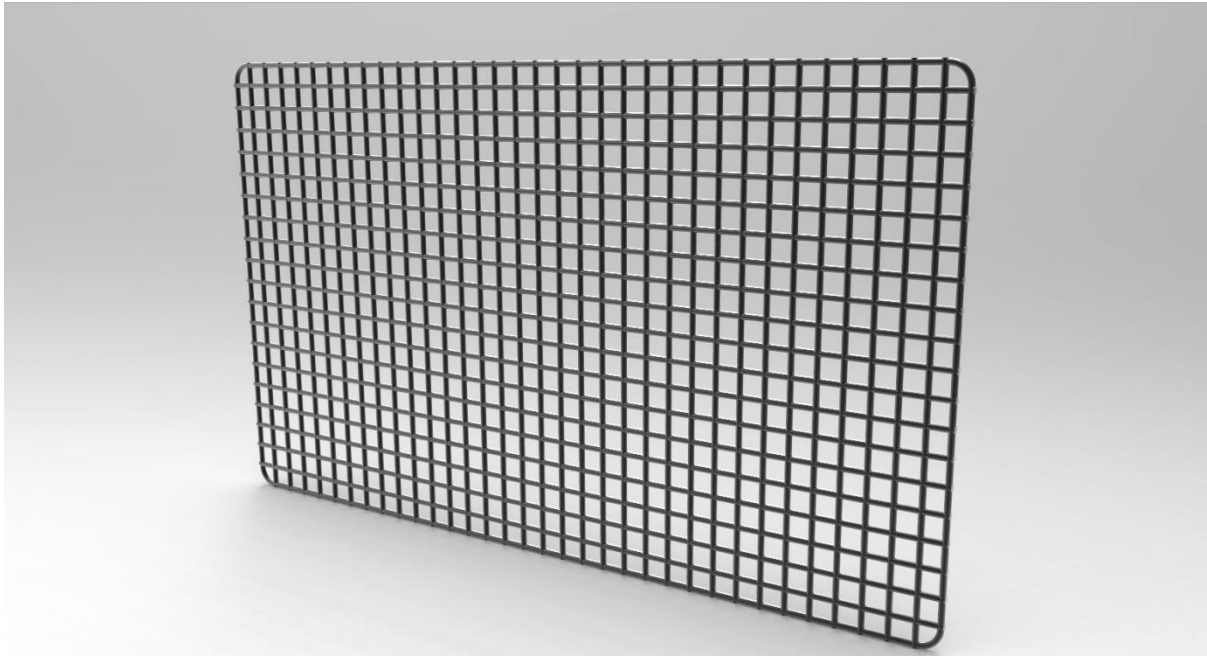

Figure 4: Molle/Recovery Grid



Figure 5: Roof Rack Feet



WARNING

Always wear appropriate PPE (Personal protection equipment) when fitting this product. Although the mounting kit is designed to be DIY, if you have any doubts or concerns, contact an accredited fitment centre to carry out the work. Alu-Cab will not be liable for any injury to persons, and/or damage to products and/or vehicles.

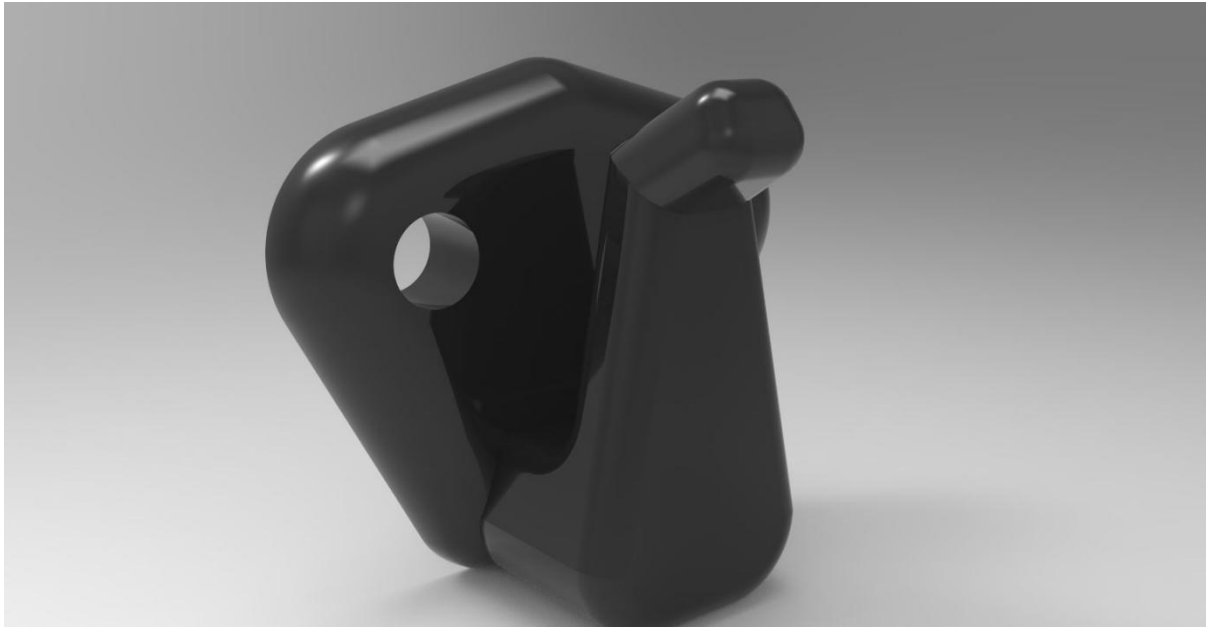

Figure 6: Black Plastic Lace Hook 3



Figure 7: Bungee Cord

Miscellaneous parts:

- Black Insulation Tape

Step 1: Carpeting

The first step in assembling the Side Chair Carrier is to Carpet the inside surface of the Main Carrier Body. The below pictures show what surfaces are referred to:



Figure 8: Main Carrier Body Carpeting



Figure 9: Main Carrier Body Carpeting



Figure 10: Main Carrier Body Carpeting



Figure 11: Main Carrier Body Carpeting

Step 2: Rivet Rear Panel Reinforcement

The next step is to rivet the rear panel bend to the top bends to reinforce the Main Carrier Body. This will use 4x Black 4.8mmx10 Rivets. The below picture shows the hole locations for these rivets:

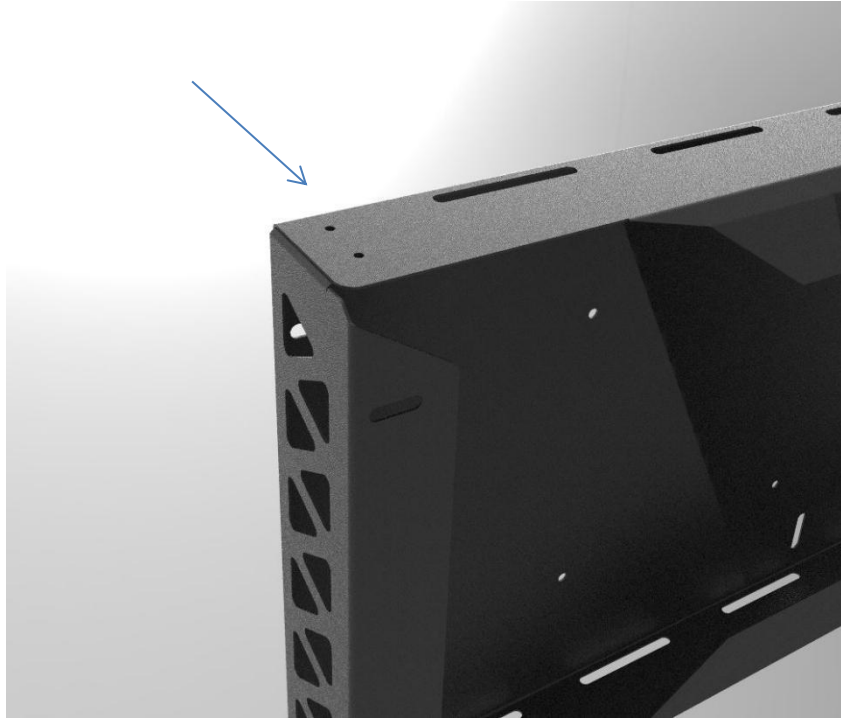
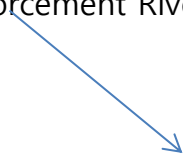

Figure 12: Main Carrier Body Reinforcement Rivet Holes



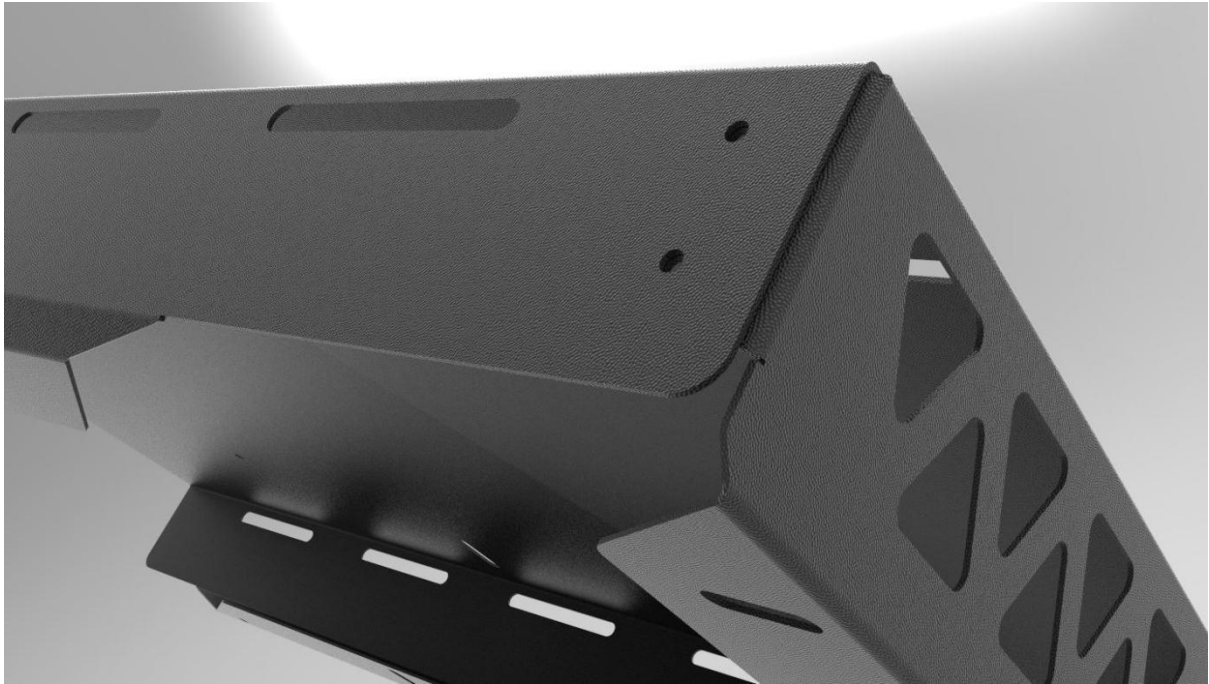

Figure 13: Main Carrier Body Reinforcement Rivet Holes

Step 3: Rivet Plastic Lace Hook

The next step is to rivet in the Black Plastic Lace Hook, there are 2 holes laser cut to place and rivet it. You need to place the Lace Hook on the carpet, align the holes with it, then cut the carpet around the lace hook and remove it to mount it flush. Then rivet it securely to the Main Carrier Body.

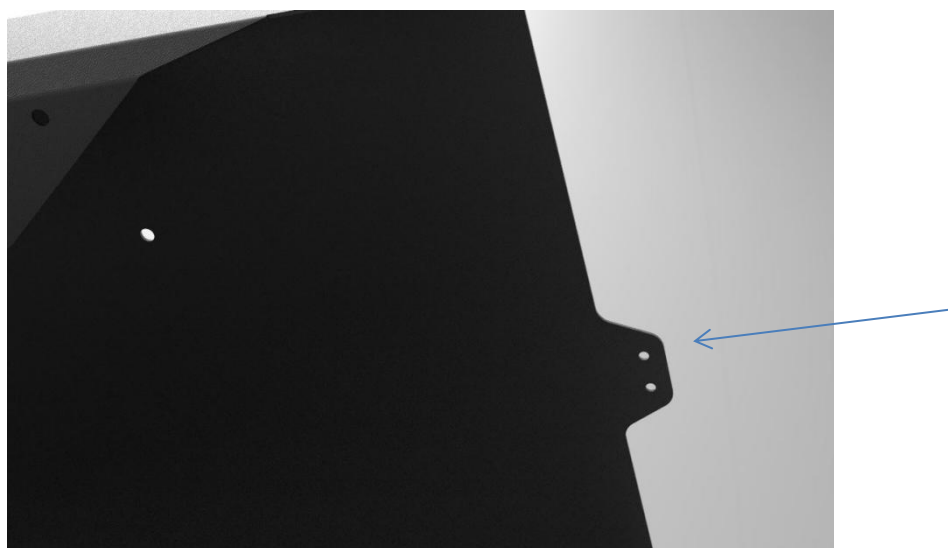

Figure 14: Main Carrier Body Lace Hook Holes



Figure 15: Main Carrier Body Lace Hook Placement

Step 4: Roof Rack Feet Mounting

Now the Roof Rack Feet must be mounted to the Main Carrier Body. As shown in the below images, they will mount to the Main Carrier Body using 4 (2 each per foot) M8x20 Cup Square Bolts, 4 M8x16 Flat Washers, 4 Nyloc Nuts M8, and finally 4 Nut Caps. The carpet covering these slots will have to be drilled/cut out.

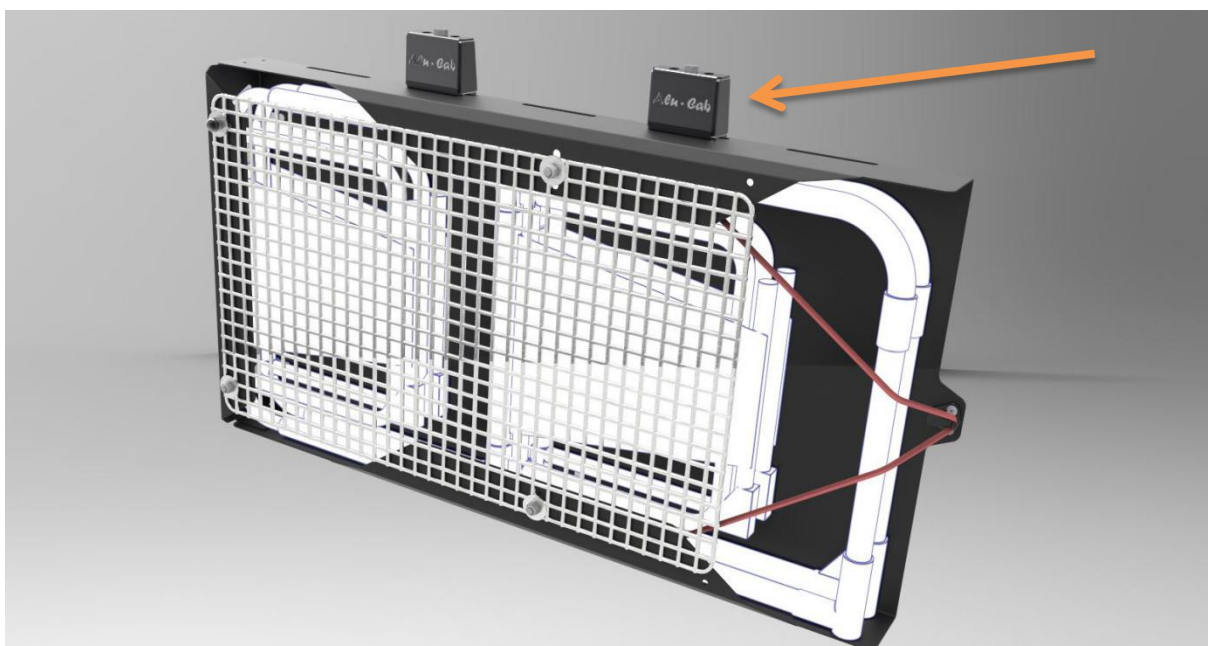

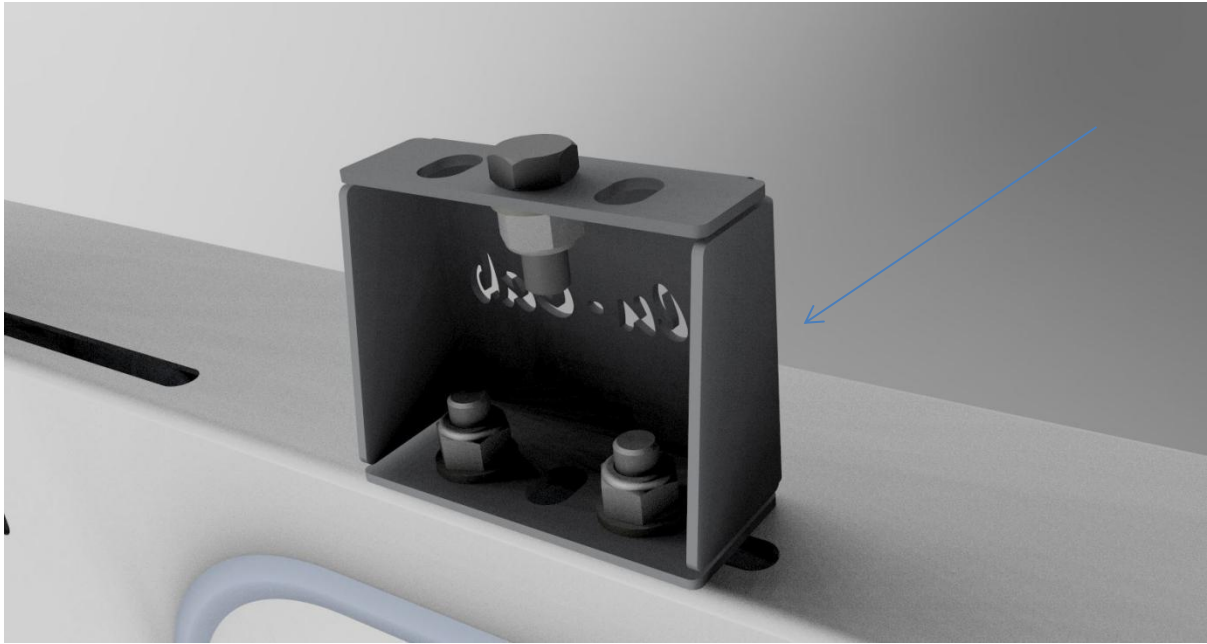

Figure 16: Main Carrier Body Roof Rack Feet Fitment

Step 5: Bungee Cord Mounting

Next is to tie 6mm Bungee Cord to the provided holes. These will be tied with a single knot towards the outside of the Carrier, with the ends of the cord wrapped in insulation tape to protect against fraying.



Figure 17: Bungee Cord Fitment



Figure 18: Bungee Cord Fitment

Step 6: Shelf Bracket Assembly

In this step we need to attach the Shelf Bracket Kit to the rest of the Chair Carrier. There are slots laser cut into the rear of the Chair Carrier for the Shelf Bracket, which has corresponding slots. These slots provide a fixture point as well as height adjustment for the Shelf Bracket. The following pictures show the process of fastening the Shelf Bracket to the Chair Carrier.

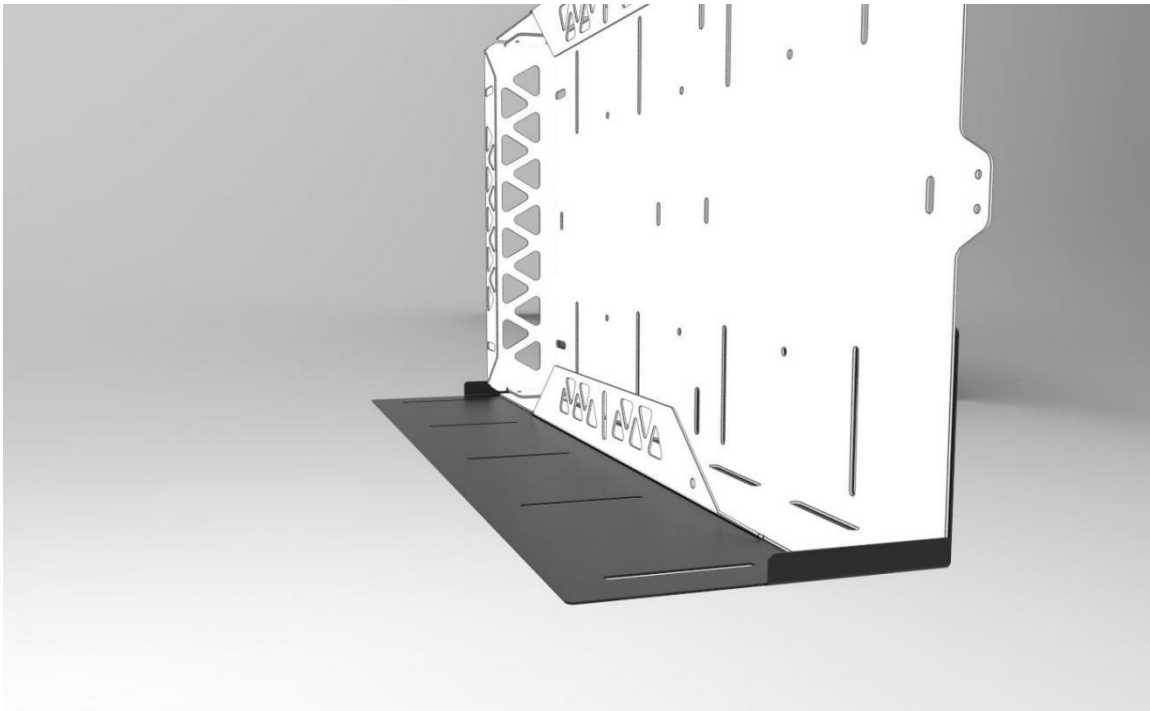

Figure 19: Shelf Bracket Kit

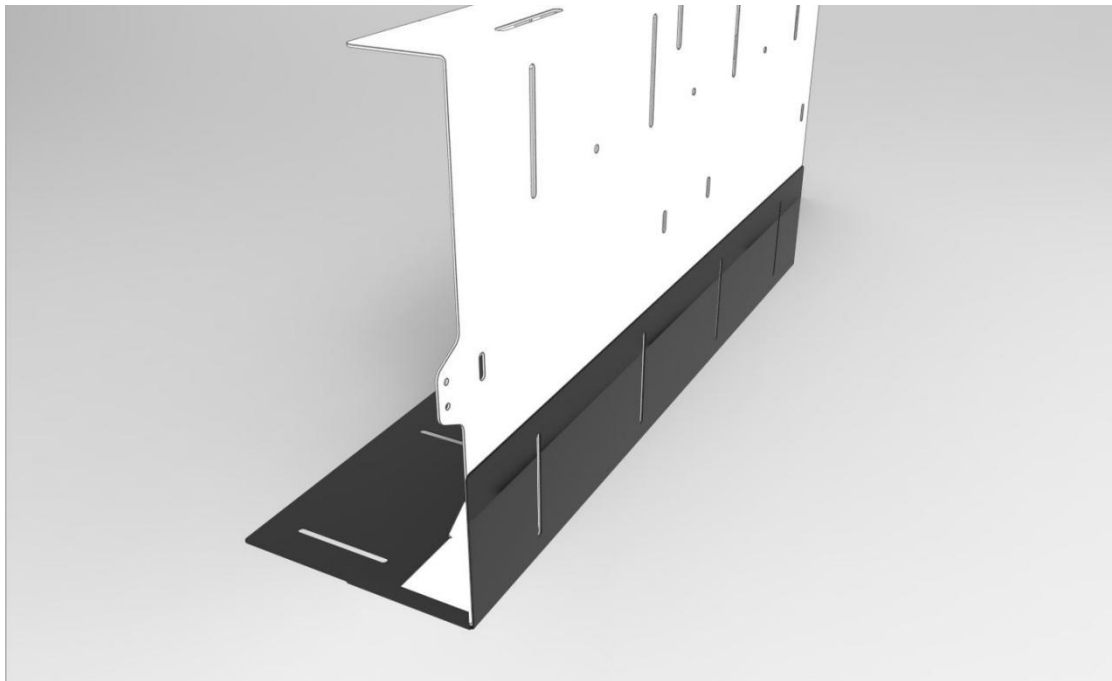

Figure 20: Shelf Bracket

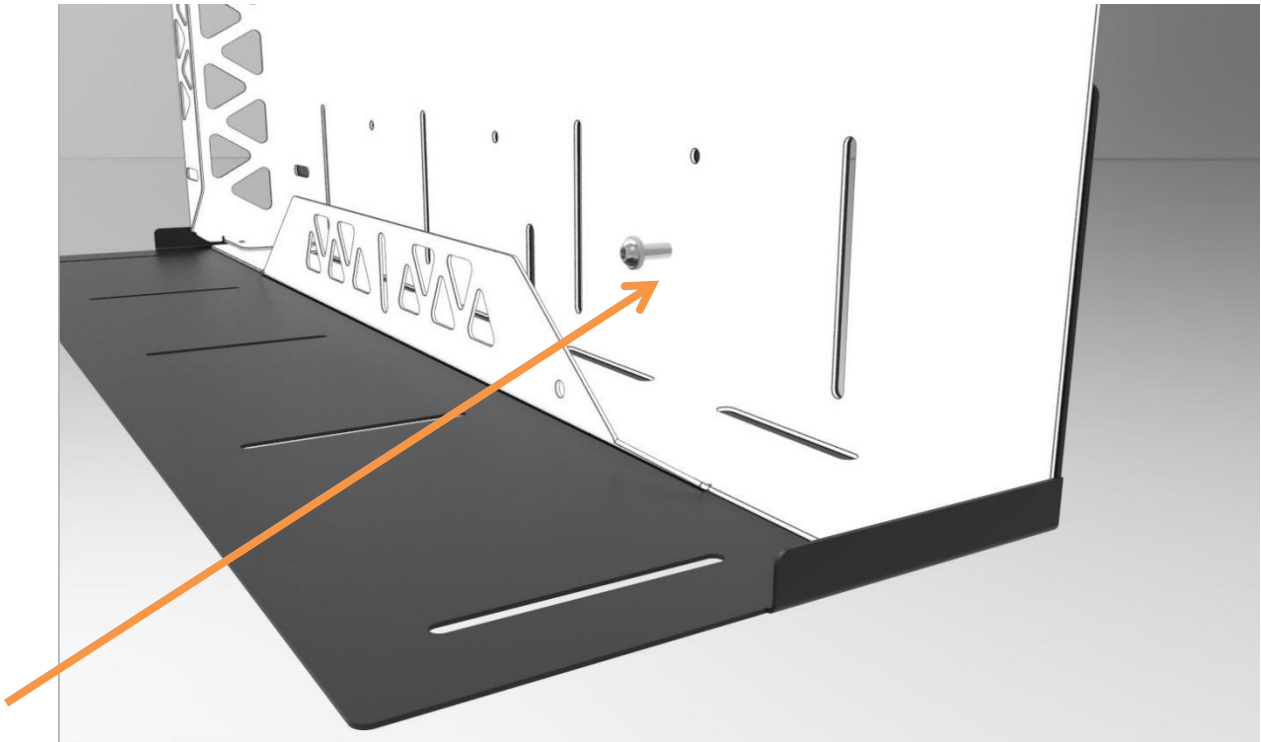

Figure 21: Place an M6 Button Head Cap Screw with washer, from the inside of the Carrier, through each slot.

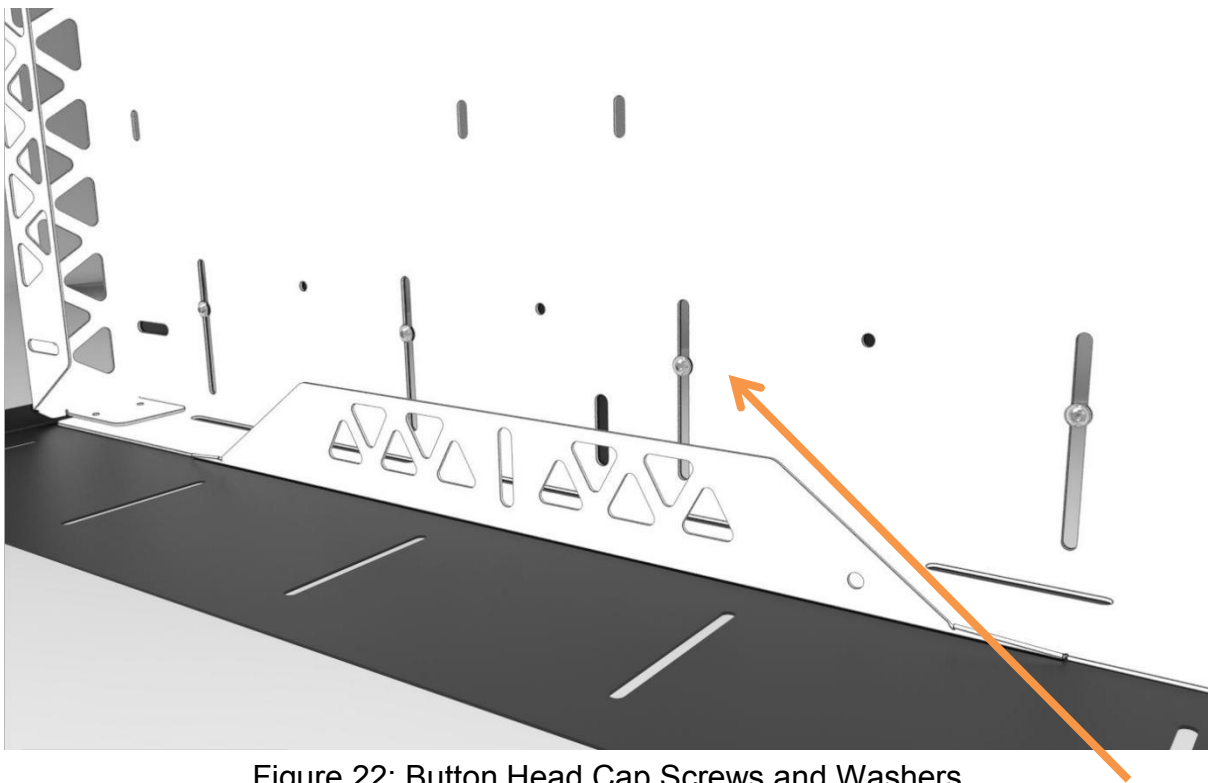

Figure 22: Button Head Cap Screws and Washers

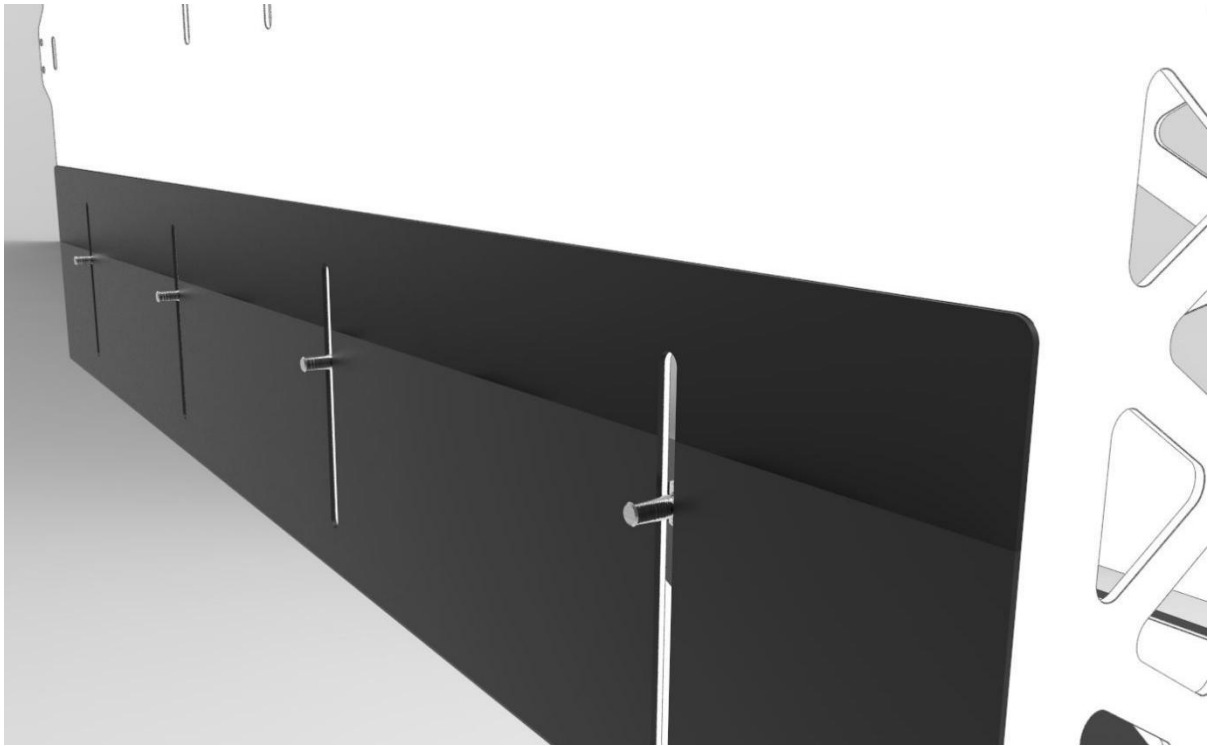

Figure 23: Rear of Chair Carrier and Shelf Bracket

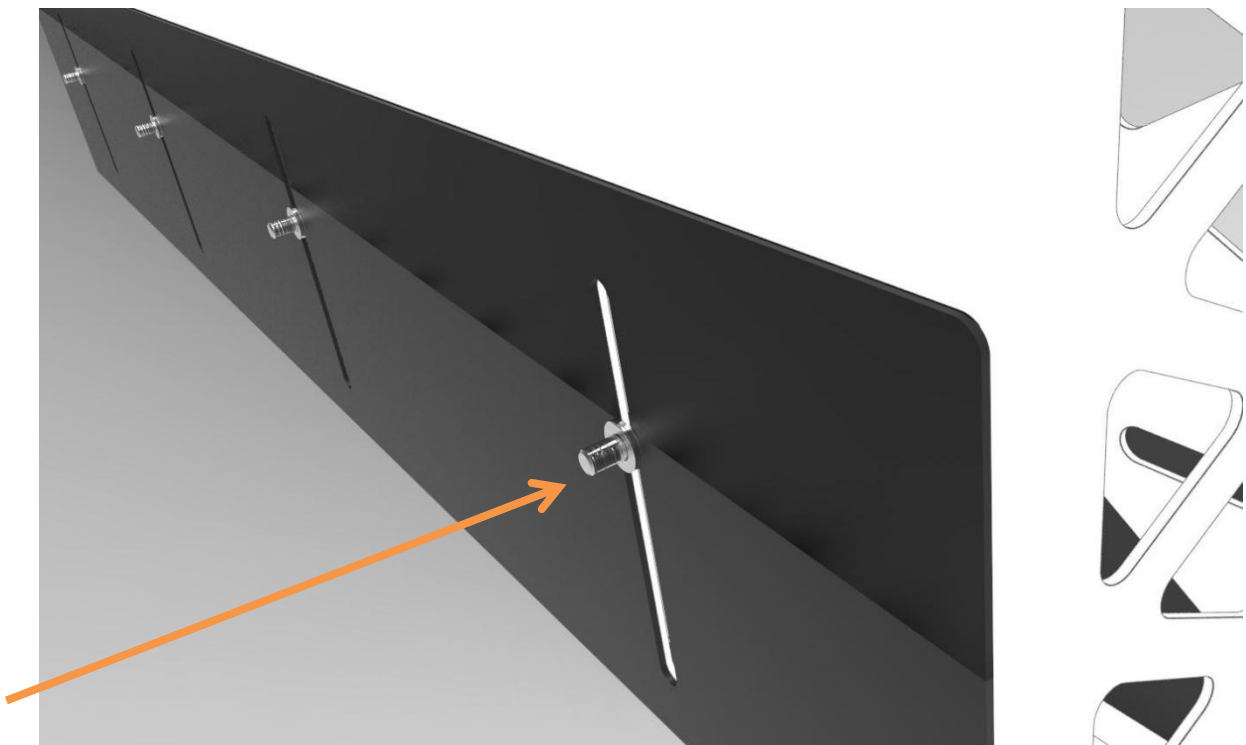

Figure 24: Place another washer over the M6 Bolt on the Rear of the Shelf Bracket

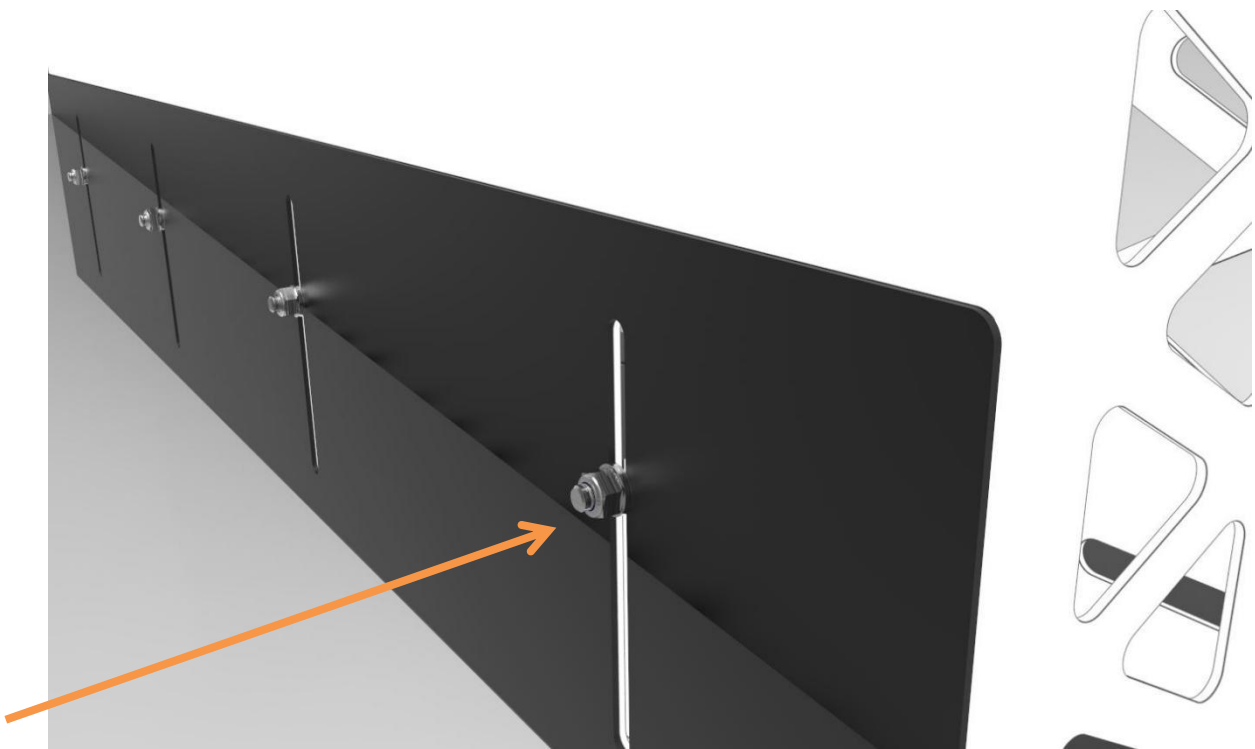

Figure 25: Fasten the Bracket on securely to the Chair Carrier using M6 Nyloc Nuts

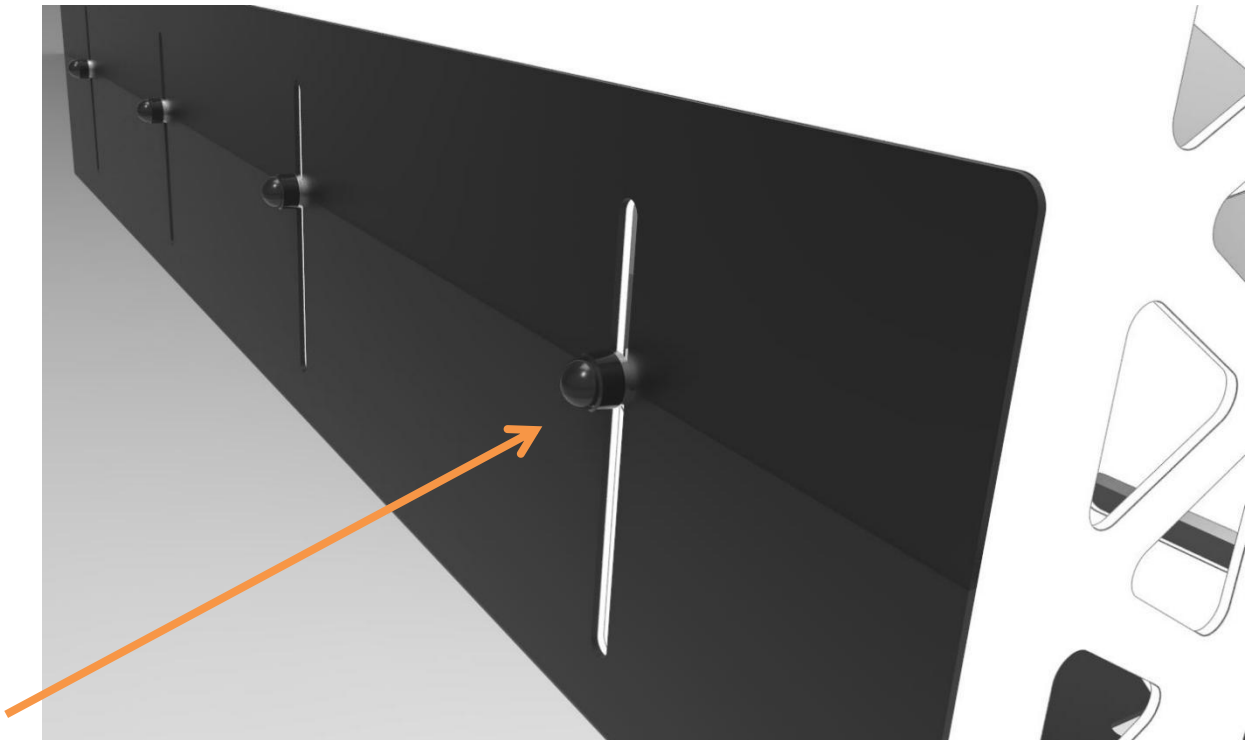

Figure 26: Complete this Shelf Bracket assembly with Nut Caps

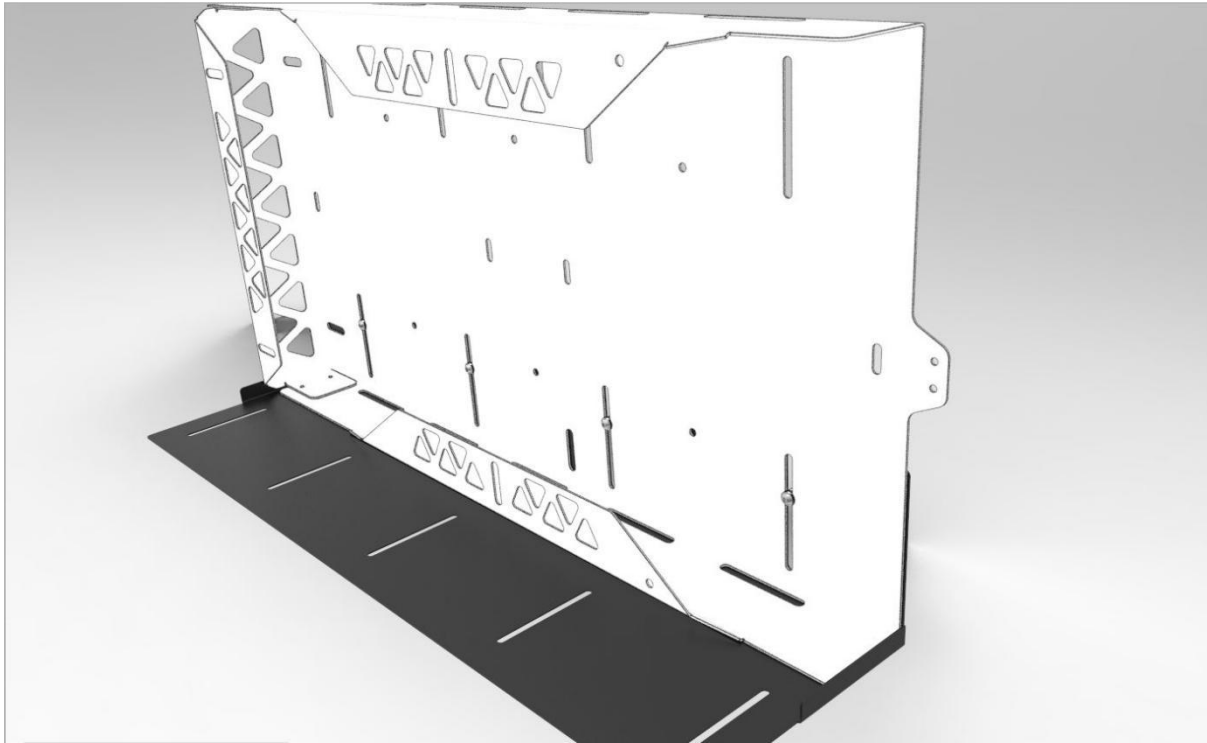

Figure 27: Shelf Bracket Assembly

Step 7: Molle/Recovery Grid Fitting

For this step we will be fastening the Molle/Recovery Grid to the Main Carrier Body. You will use 4 M8x20 Cup Square Bolts, 4 Nyloc Nuts M8, 4 M8x35mm Washers and 4 M8 Nut Caps. You will bolt from the inside of the provides slots outwards, fixing the Grid in place using the washers over the mesh, as shown below.

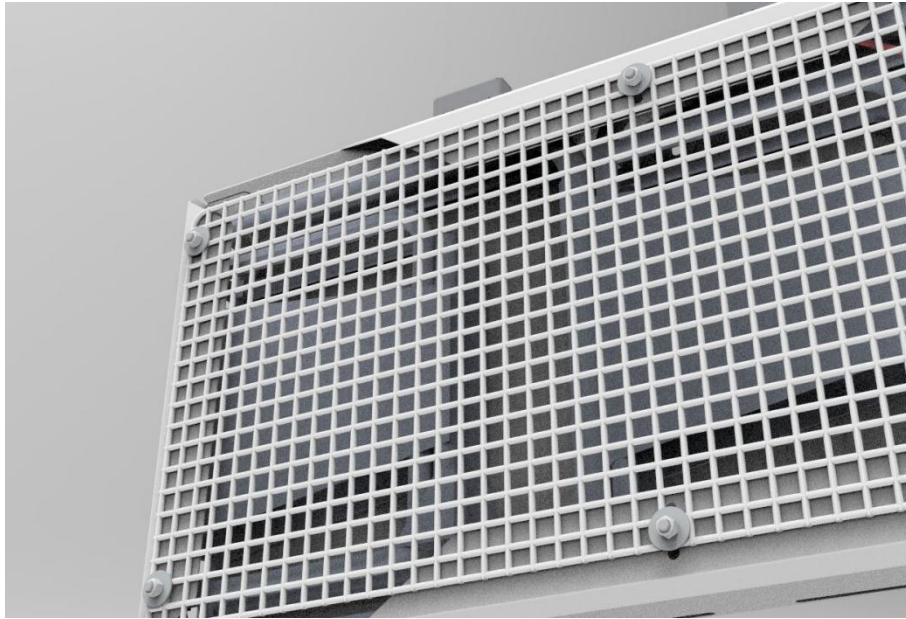

Figure 28: Molle/Recovery Grid Fitting

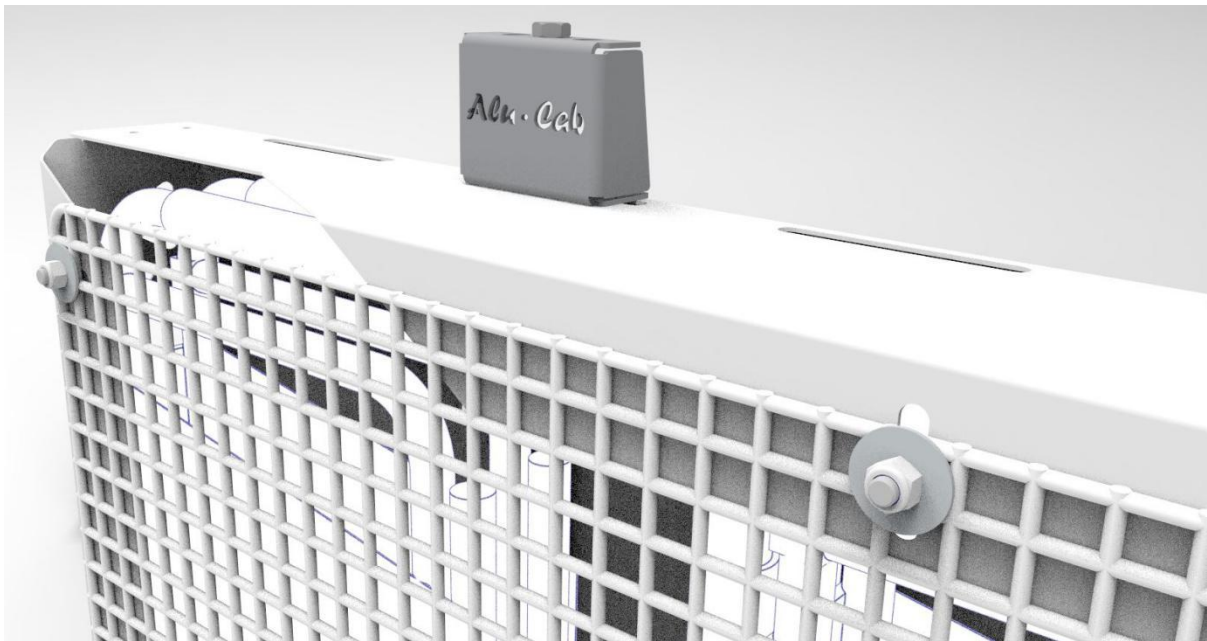

Figure 29: Molle/Recovery Grid Fitting

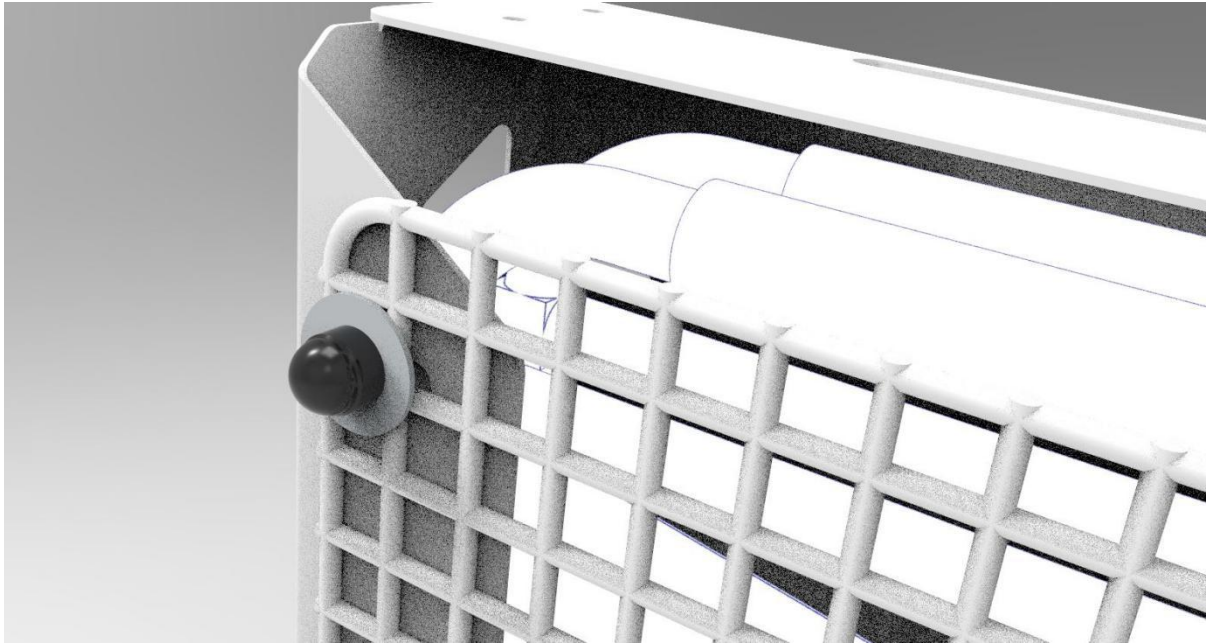

Figure 30: Molle/Recovery Grid Fitting

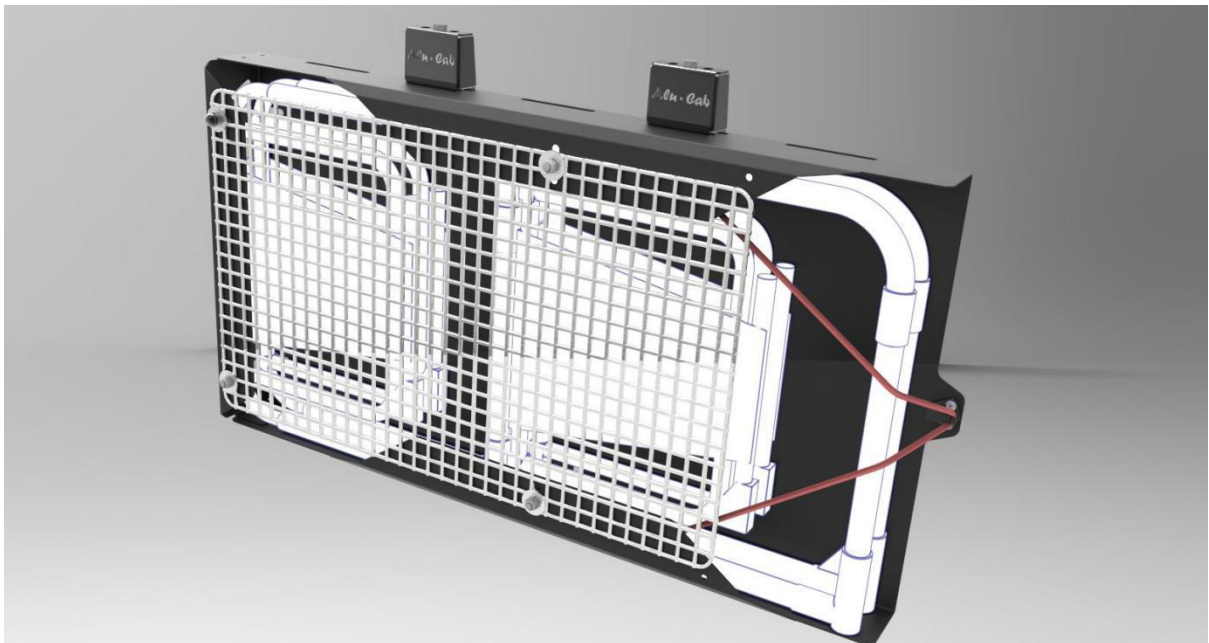

Figure 31: Side Chair Carrier

Step 8: Chair Carrier Shelf Mount Assembly

In this step we need to fasten the Shelf Mount Bracket to the Shelf Bracket. This will be used to mount our Chair Carrier to the side of our Canopy, and create the other half of our Shelf. There are slots on the Shelf Bracket that correspond to slots on the Shelf Mount Bracket, this is where we will fasten our Shelf Mount Bracket. The below pictures will show this.

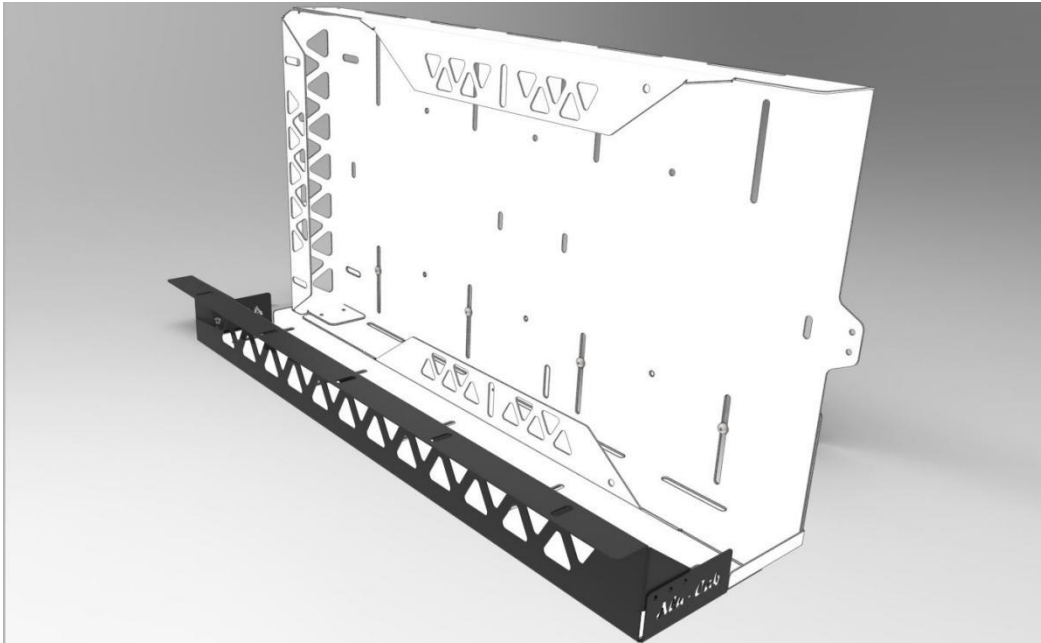

Figure 32: Shelf Mount Bracket

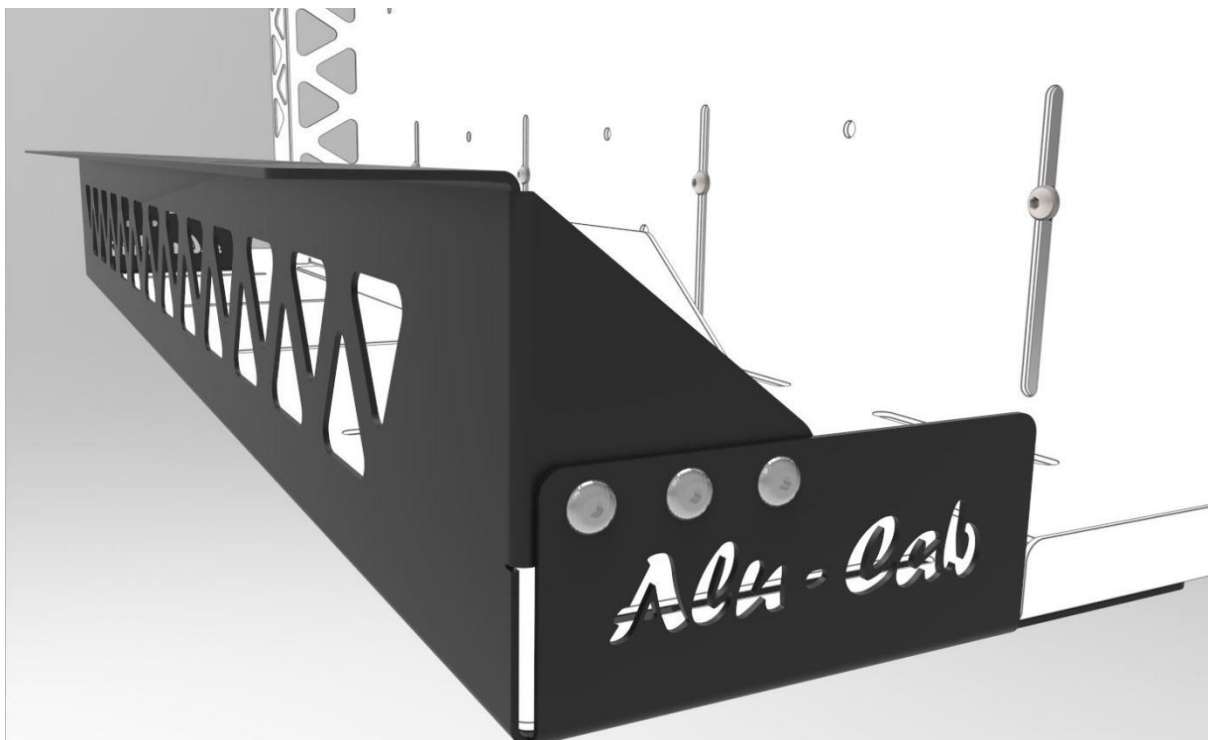

Figure 33: Rivet 3 Rivets into the corresponding laser cut holes on the side gussets of the Shelf Mount Bracket, on both sides



Figure 34: Side gussets for Shelf Mount Bracket

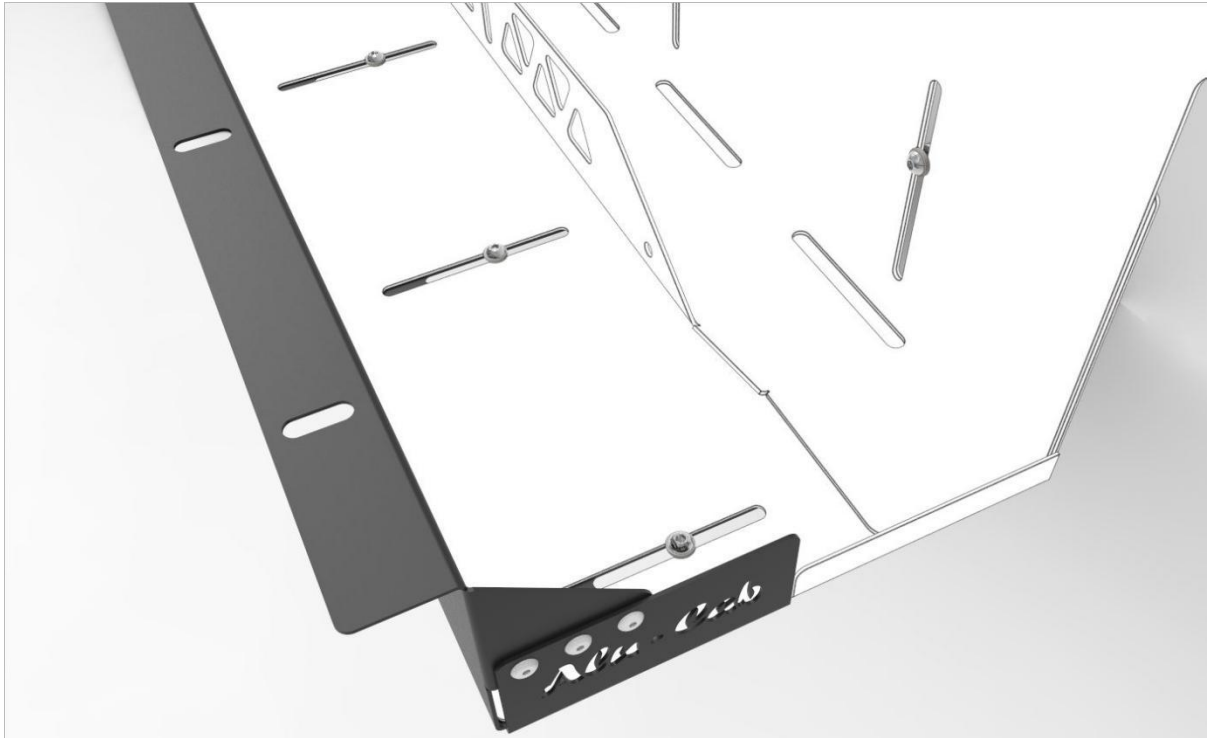

Figure 35: Place a Button Head Cap Screw in each slot with a washer

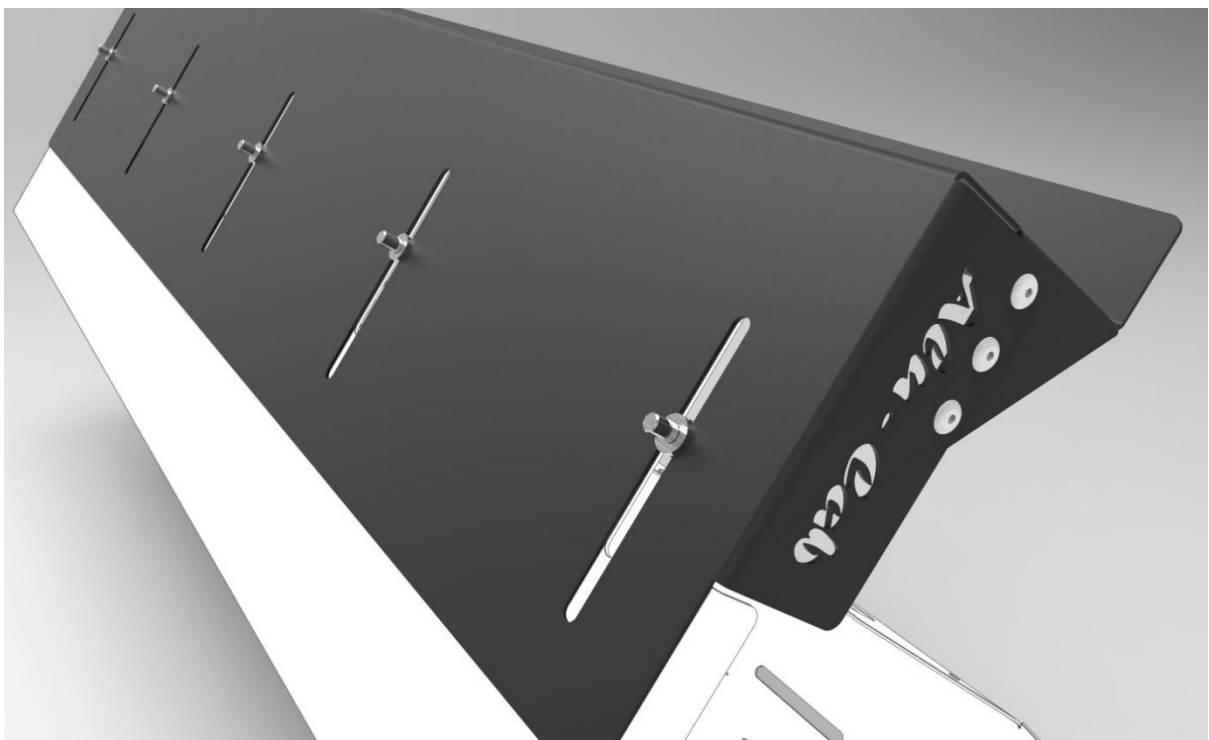

Figure 36: Place a washer on the bottom side of the Shelf Mount Bracket over each bolt



Figure 37: We can now place a Nyloc Nut on each Bolt and fasten the Brackets securely together

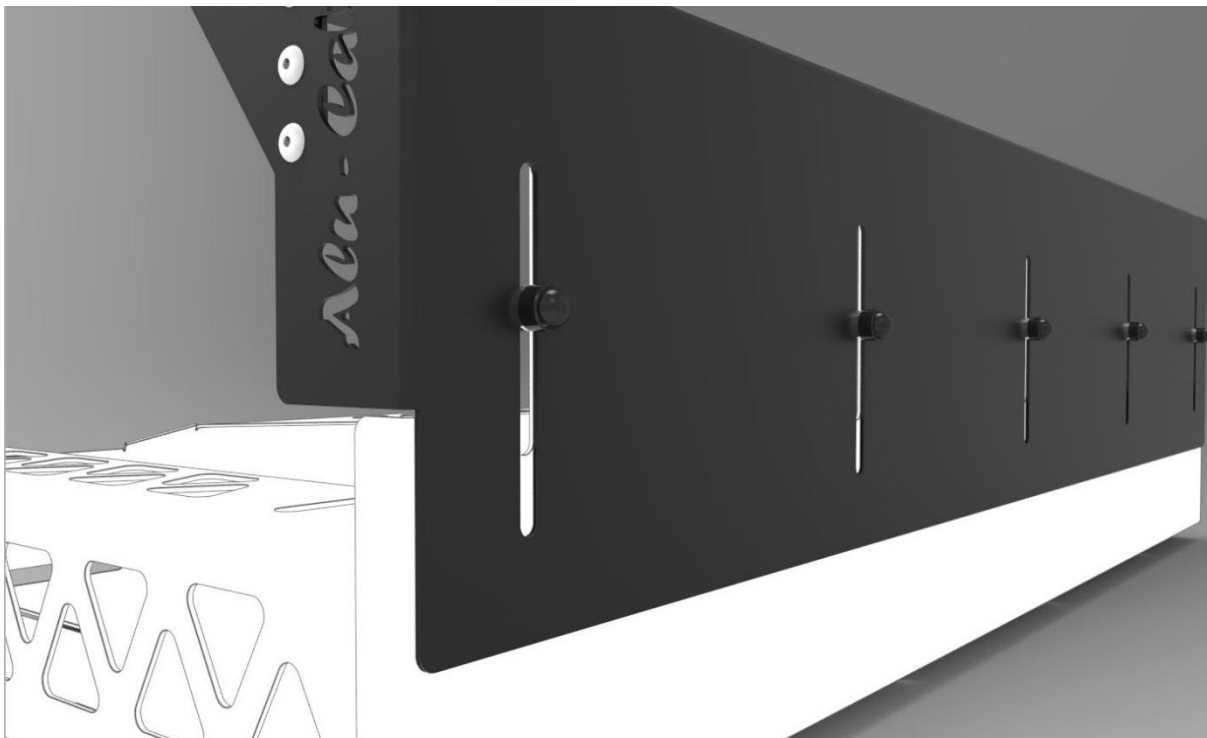

Figure 38: To finish this assembly we place a Nut Cap on each Nut

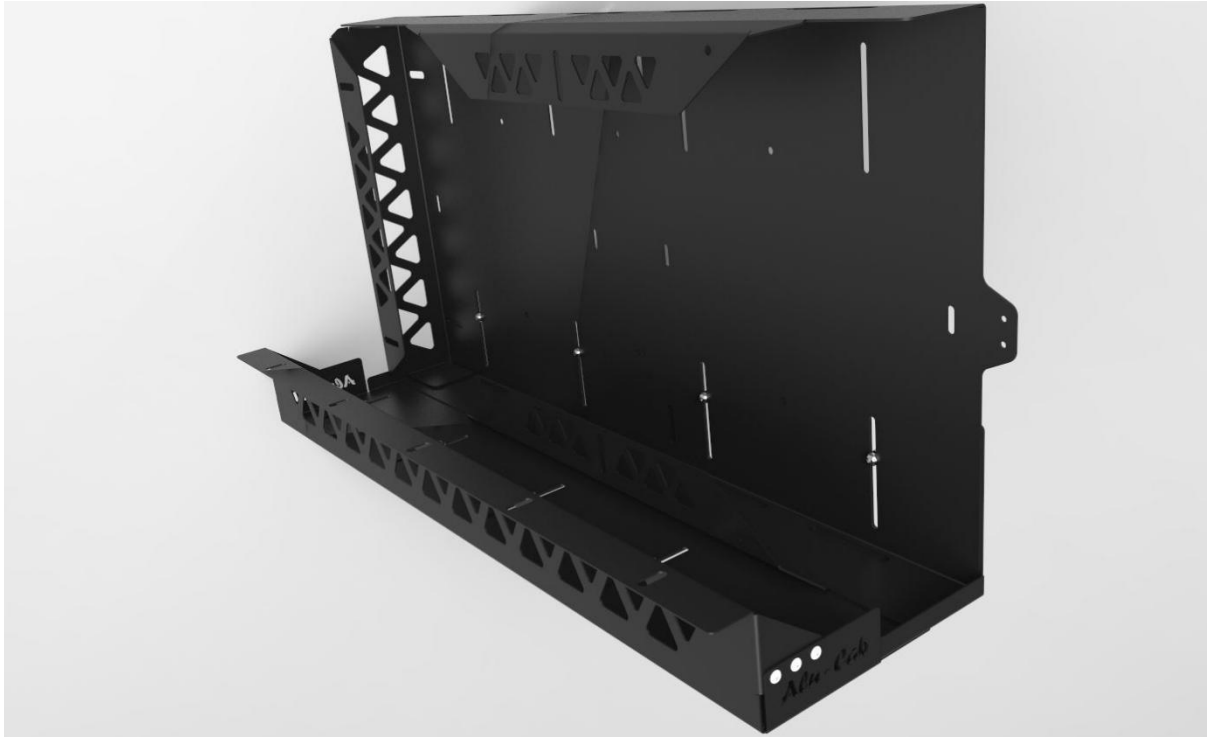

Figure 39: Complete Shelf Assembly

Double Chair Carrier Assembly

To the Double Chair Carrier is an optional configuration for the buyer, the doubles up the chair carrying ability of the Chair Carrier, placing a second Main Carrier Body behind the first one. The Chair Carrier will now be able to carry 4 Front Runner Camping Chairs.

NB* It is important to note that if it is required to assemble a Double Chair Carrier, that the following steps are done after Step 5 of the Single Chair Carrier Assembly Process. Once these steps are complete you can continue with step 6 onwards.

Step 1: Second Main Carrier Body Placement

For this first step we need to place the prepared Main Carrier Bodies ontop of each other as shown in the pictures below.

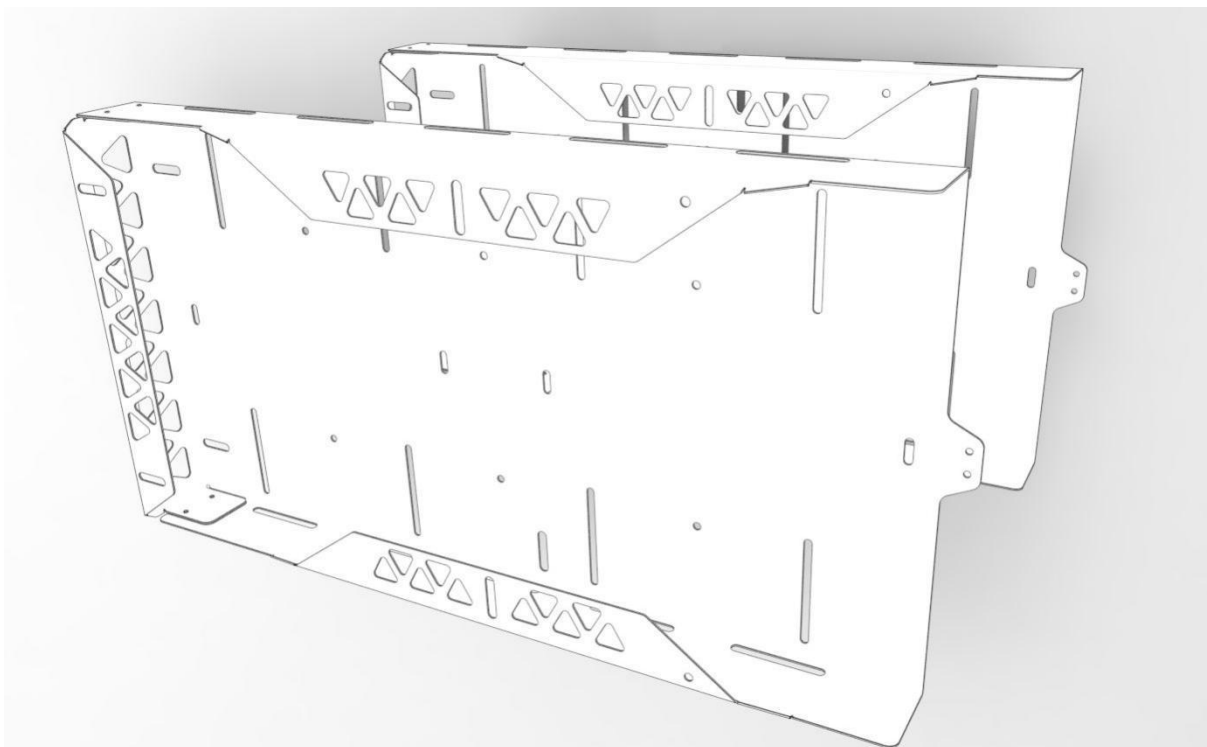

Figure 1: 2x Main Carrier Bodies for Double Chair Carrier

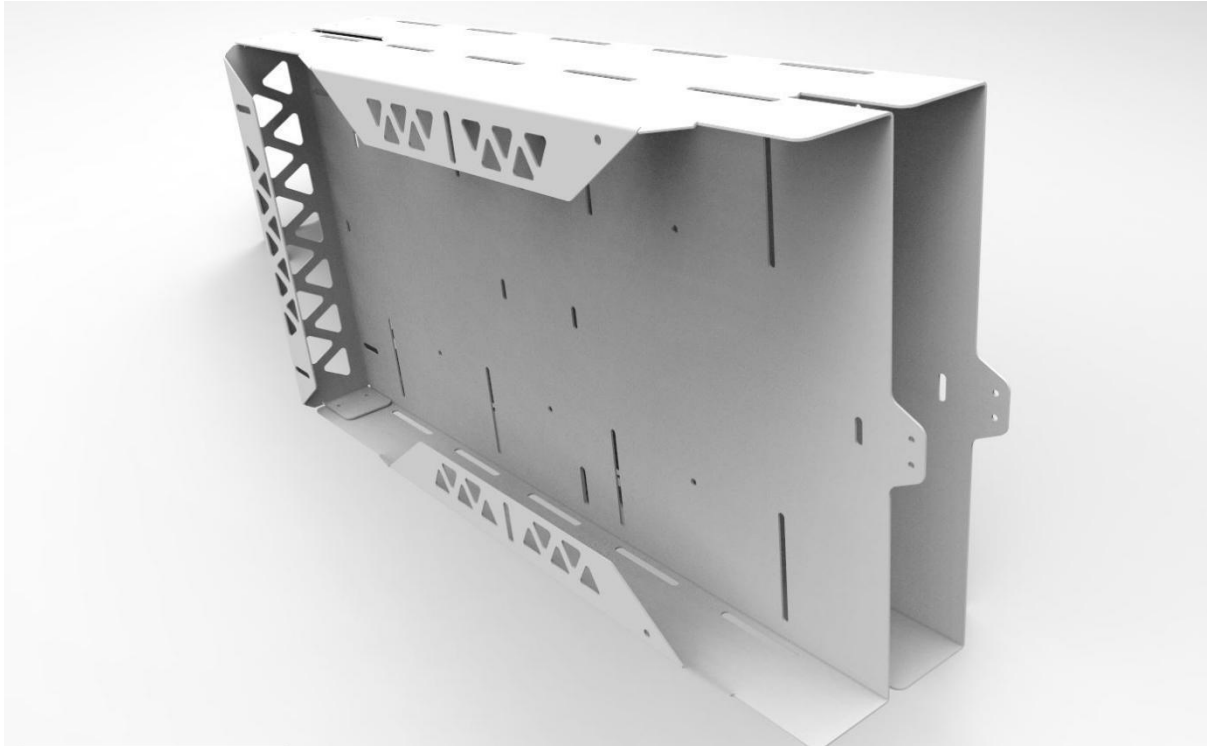

Figure 2: Chair Carrier Main Bodies positioned flush on all edges

Step 2: Cup Square positioning and fastening

In this step we need to position our M8 Cup Square Bolts in the provided slots, to fasten our 2 Chair Carrier Main Bodies. We will use the slots provided for the Single Chair Carriers Braai Grid/Molle Plate/Recovery Grid, the 4 slots used to fasten the grid to the Carrier. The below images show these slots with the Cup Square Bolts positioned.

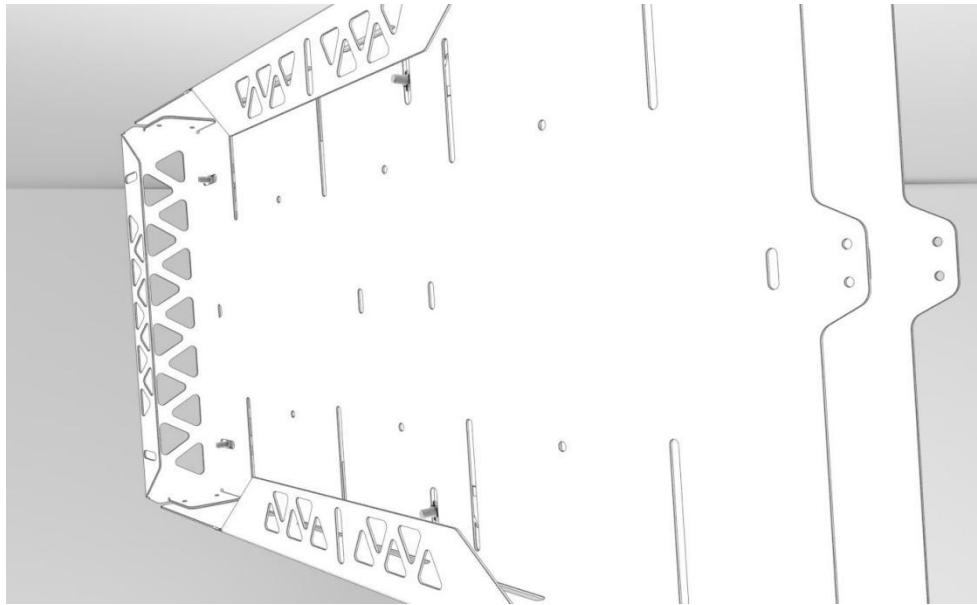

Figure 3: Cup Square Bolt Positioning in Slots

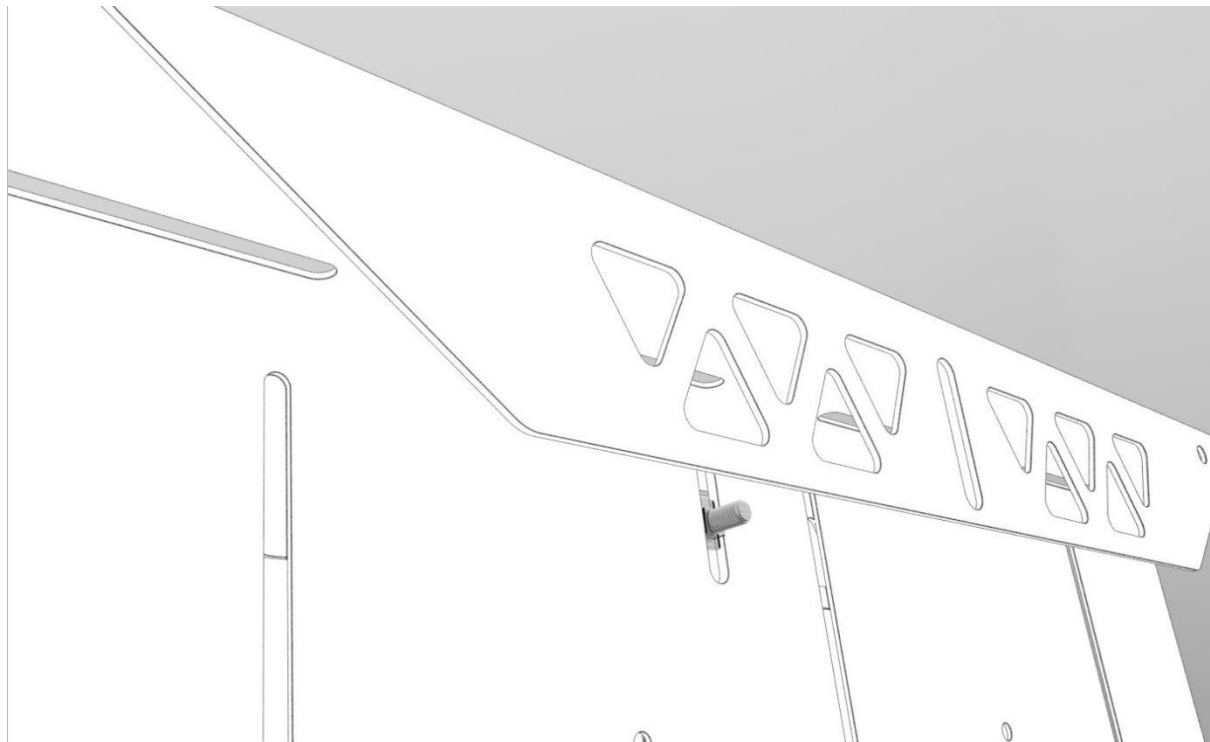

Figure 4: Vertical Slot

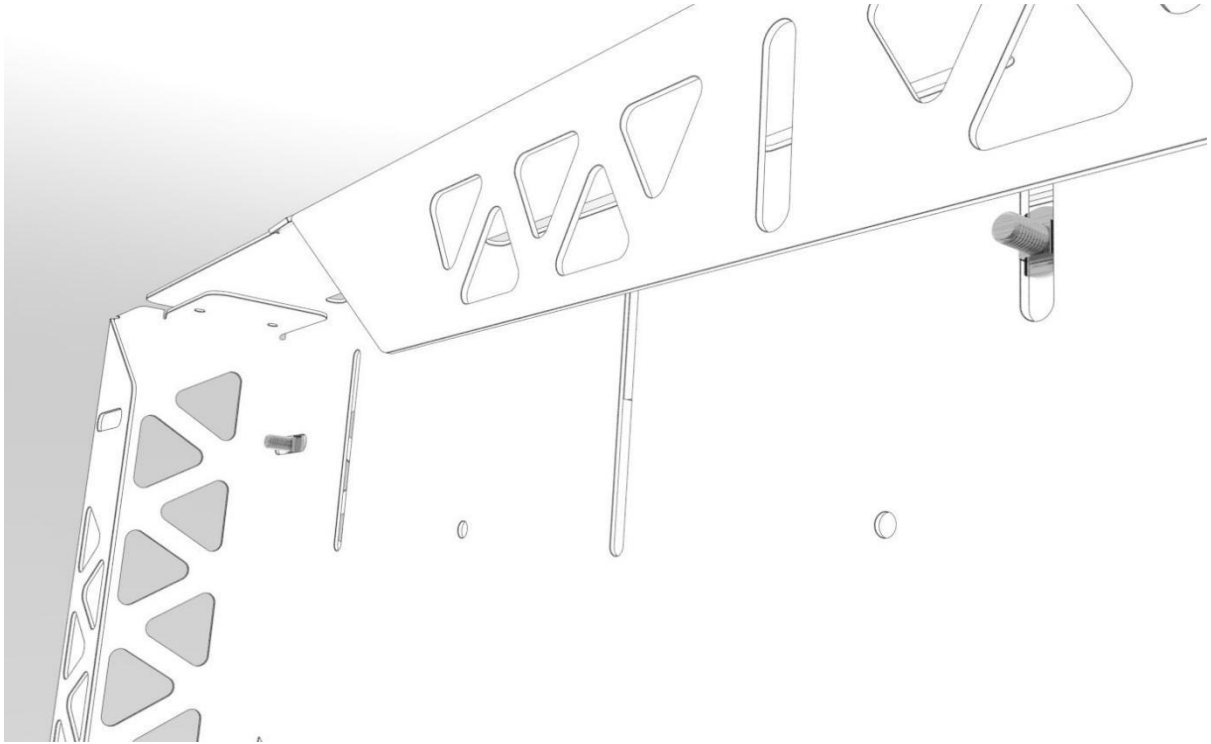

Figure 5: Vertical and Horizontal Slot

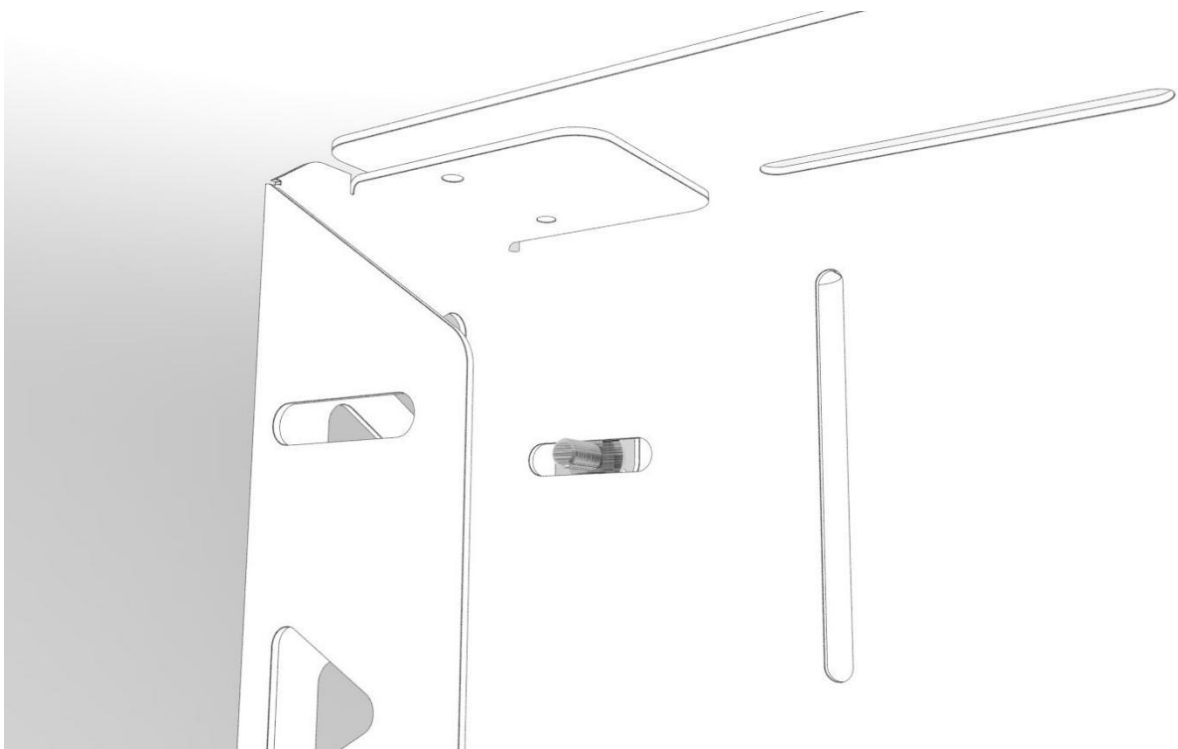

Figure 6: Horizontal Slot

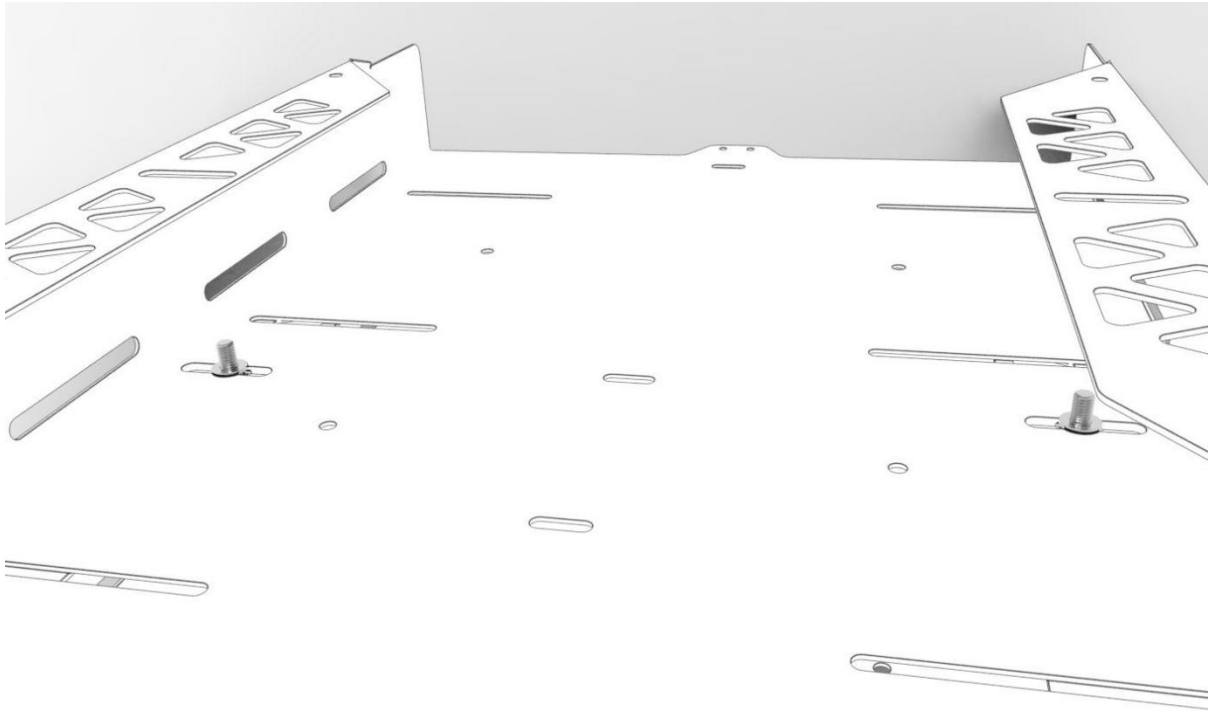

Figure 7: Place Washers on the Cup Square Bolts

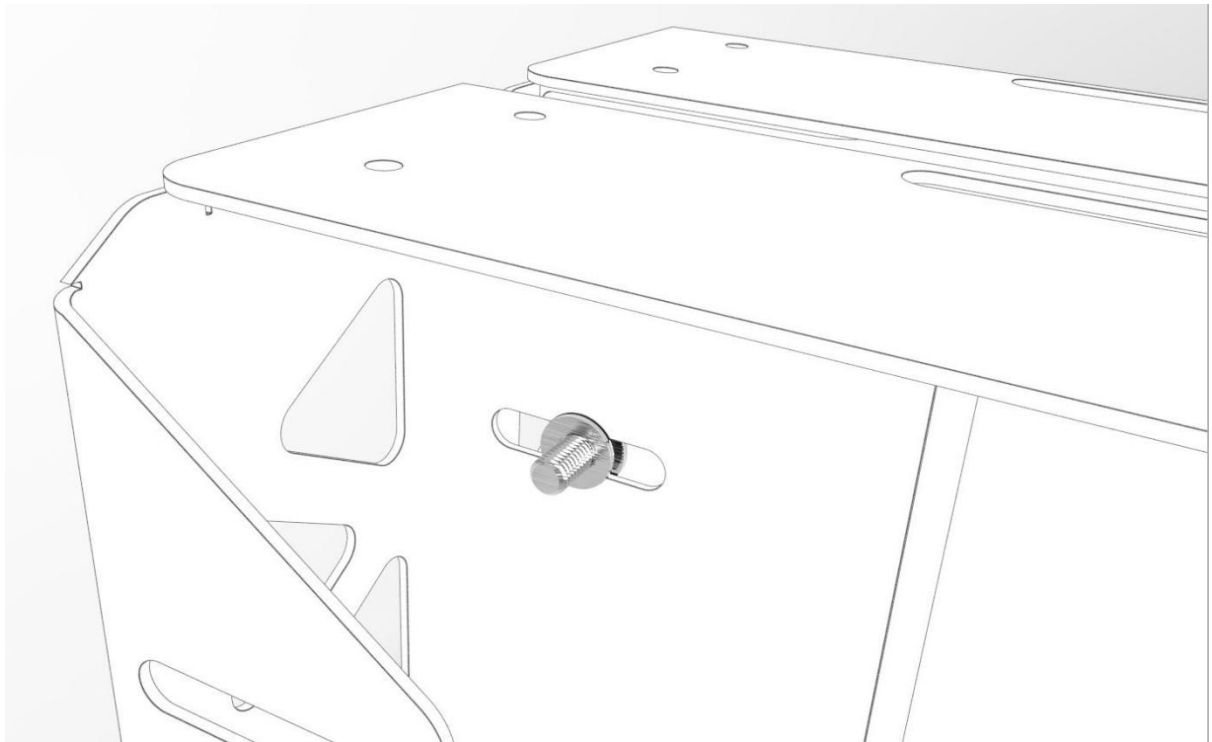

Figure 8: Washer placed on Cup Square Bolt

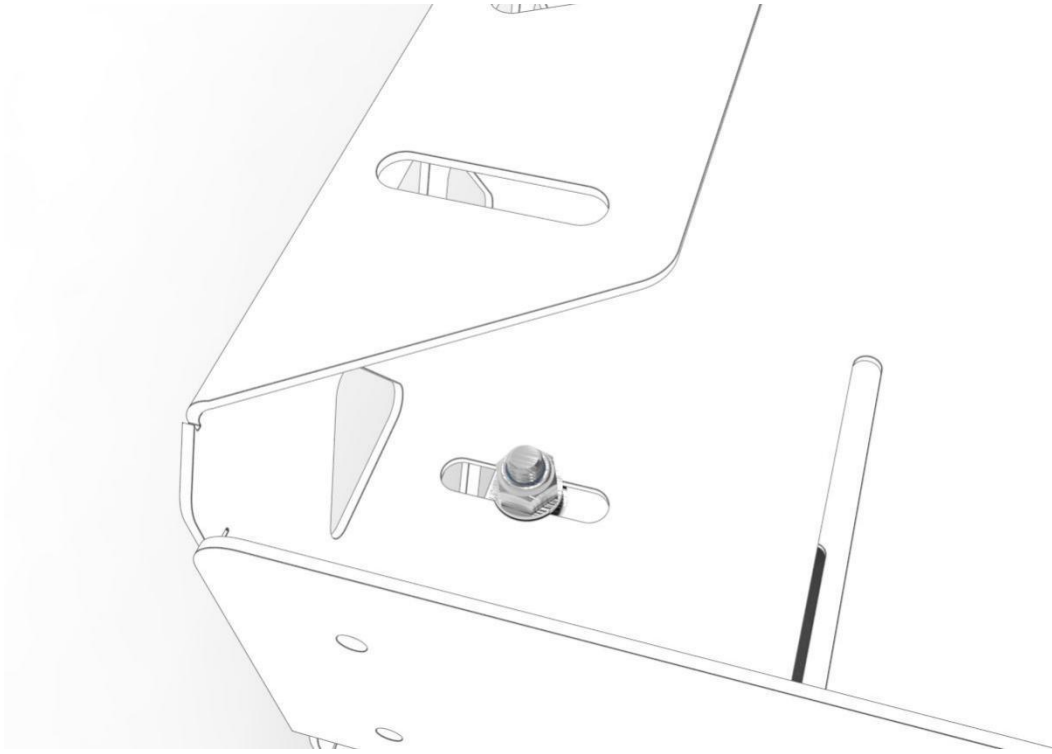

Figure 9: Place a Nyloc Nut on each of the 4 Cup Square Bolts

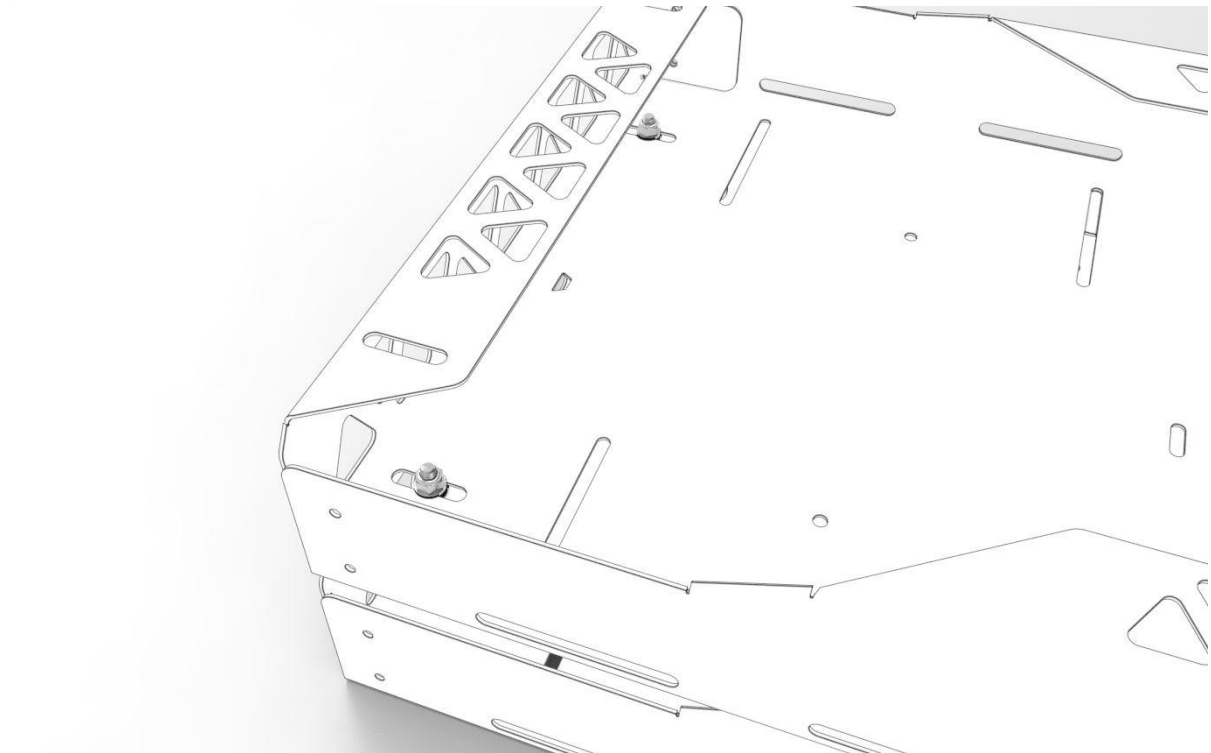

Figure 10: Nyloc Nuts fastened securely



Figure 11: Double Chair Carrier Main Bodies with Shelf

Step 3: Continue

At this point we can continue with steps 6-8 as with the Single Chair Carrier to complete the Double Chair Carrier.

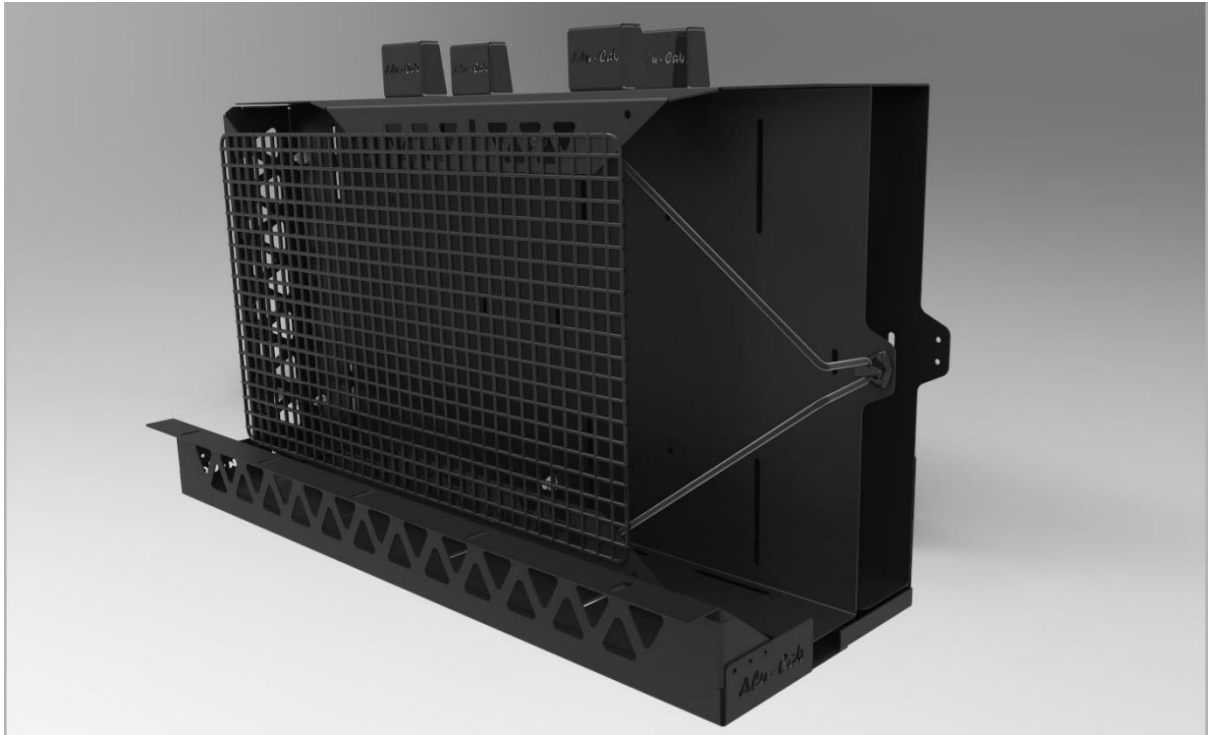

Should you experience any problems, please contact us so that we can assist you.

Enquiries: queries@alu-cab.co.za
Tel: +27 21 703 3028